



LIGHTBARS

Rampes lumineuses
Lichtbalken

Ultimax	2
Lomax	4
Midimax	6
Optimax	8
Maxim	10
Emax	12
Arrowbars	13
Aeromax	14
Minimax	15
Traffic Max	16
MX 7000	17
Lightbar Spares	18



LED

Directional LED Lighting	20
--------------------------	----



COVERT LIGHTING

Covert Lighting Equipment	24
---------------------------	----



SIRENS & SPEAKERS

Sirènes et haut-parleurs
Sirenen und Lautsprecher

Sirens	26
8000 Series	28
Speaker Kits	29



BEACONS

Gyrophares
Rundumleuchten

Halogen Rotating Beacon Range	30
Optic Beacon Range	32
Strobe Beacon	33
Double Flash Strobe Beacon Range	34



AUXILIARY EQUIPMENT

Equipements auxiliaires
Zusätzliche Ausrüstung

Strobe Power Supplies	35
Directional Lighting Heads	36
Flasher Units	42
Switches & Relays	44
Control Units	45
Motorcycle Systems	48
Electro-Flare	49



MESSAGE SYSTEMS

Panneaux messages variables
Leuchtschriftenanlage

Infosigns	50
-----------	----



SEARCH, WORK AND FLOODLIGHTING

Phares de recherche
Arbeitslicht

Nightscan Lighting Masts	52
Search & Work Lights	54



Ultra Low Profile, Versatile, **Two Layer** or **Single Deck** Lightbar

Height: 138mm (5.4") Width: 346mm (13.6") Length: up to 2070mm (82")

- 360° and standard LED options
- Low profile, two layer aerodynamic design
- Polycarbonate lens
- Effective lens seal
- Designed to use latest high intensity LED directional lights
- Halogen and strobe options available
- Can be built as single layer lightbar

E11 Approved to regulation ECE65
Amber- Halogen only
Blue- Strobe only

e11 Approved to automotive
EMC directive 95/54/EC



Roof connector

Optional bespoke lettering, logo's and a variety of non standard options are available for all Premier Hazard Ultimax lightbars



Wind Tunnel Tested 130mph 208kph

For Mount Kit Options and for Common Lightbar Spares see pages 18-19

Lengths

- Available Lengths: 895mm (35"), 1118mm (44"), 1245mm (49"), 1372mm (54"), 1473mm (58"), 1626mm (64"), 1727mm (68"), 2070mm (82")

- Available Colours: Amber California Blue Clear E11 Blue Red

Options

Rotator Assemblies

- 12 / 24v Rotator
- Dual Voltage rotator
- 12 / 24v Rotatory
- 12 / 24v Oscilasers
- Synchronised rotators to suit ECE65
- Airport Rotator 12v motor 24v bulb

Halogen Warning

- Small alternating lights 27watt available in a variety of colours

Strobe Heads

- 360° Strobe Double Flash 12/24v
- Small linear strobe

Strobe Power Supplies

- 2 output 40 watt supply
- 2 / 4 output 60 watt supply
- 2 / 4 output 75 watt supply
- 2 / 4/6 output 75 watt supply
- 2 / 4 / 6 output 90 watt supply

Camera Bracket

- Bracket kit for mounting ANPR camera

Signs & Grilles

- Centre sign
- Speaker grille
- Flashing STOP sign

Spot / Flood Lighting

- Spot / flood lights
- 2 / 4 alley lights

LED's

- LEDX 12 / 24v single head LED's
- 360 degree LED's

Infosigns

- 45mm 1 / 2 messages or police messages only
- 60mm 2 / 3 messages or police messages only
- 75mm 3 / 10 messages or any messages required
- 90mm 10 / 30 / 99 messages or police messages required
- 90mm programmable software available

Speakers

- 60 / 100 watt

Roof Connector

- 15 metres of cable with male and female connections

Arrow Bar

- Arrow bar and controller



The Ultimate Low Profile LED/Strobe Lightbar

Height: 90mm (3.5") Width: 290mm (11.4") Length: up to 1741mm (68")

- Standard LED options
- Aerodynamic design for minimal wind resistance on high speed vehicles
- New strobe power supplies and heads for higher visibility and increased reliability
- Easy maintenance, quick release one piece lenses
- UV stabilised polycarbonate lenses

E11 Approved to regulation ECE65 – Xenon Blue only

e11 Approved to automotive EMC directive 95/54/EC



Optional bespoke lettering and logo's available for all Premier Hazard lightbar illuminated centre sections.



For Mount Kit Options and for Common Lightbar Spares see pages 18-19

Lengths

- Available Lengths: 510mm (20"), 694mm (27"), 849mm (33"), 1036mm (41"), 1214mm (48"), 1374mm (54"), 1476mm (58"), 1741mm (68")

- Available Colours:  Amber  California Blue  Clear  E11 Blue  Magenta (not EU)  Red

Options

Halogen Warning

- Small alternating lights 27 watt available in a variety of colours

Strobe Heads

- 360 degree Strobe Double Flash 12 / 24v
- Large Linear Strobe
- Small Linear Strobe
- Small Rectangular Strobe

Strobe Power Supply

- 2 output 40 watt supply
- 2 / 4 output 60 watt supply
- 2 / 4 output 75 watt supply
- 2 / 4 / 6 output 75 watt supply
- 2 / 4 / 6 output 90 watt supply

Signs & Grilles

- Centre sign
- Flashing STOP sign

LED's

- LEDX 12 / 24v single head LED's

Infosigns

- 45mm 1 / 2 message or police messages only

Speakers (raised centre required)

- 60 Watt
- 100 Watt

Spot / Flood Lighting

- 2 / 4 Alley Lights

Camera Bracket

- Bracket kit for mounting ANPR camera

Roof Connector

- 15 metres of cable with male and female connections



Low Profile Lightbar

Height: 117mm (4.6") Width: 290mm (11.4") Length: up to 2336mm (92")

- Standard LED options
- Now available with low profile speaker
- Halogen*, strobe options available
- Gear driven rotators for long life
- Rotators wired in pairs
- Integral alley lights
- Easy maintenance, quick release one piece lenses
- UV stabilised polycarbonate lenses

E11 Approved to regulation ECE65 – Halogen Amber and Blue- Xenon Blue only

e11 Approved to automotive EMC directive 95/54/EC



Dual integral alley lights



Roof connector

Optional bespoke lettering and logo's available for all Premier Hazard lightbar illuminated centre sections.



Wind Tunnel Tested 130mph 208kph

For Mount Kit Options and for Common Lightbar Spares see pages 18-19

Lengths

- Available Lengths: 510mm (20"), 694mm (27"), 849mm (33"), 1036mm (41"), 1114mm (44"), 1214mm (48"), 1374mm (54"), 1476mm (58"), 1741mm (68"), 1858mm (73"), 1958mm (77"), 2118mm (83"), 2336mm (92")

- Available Colours:

Amber	California Blue	Clear	E11 Blue	Magenta (not EU)	Red

Options

Rotator Assemblies

- 12 / 24v Rotator
- Dual Voltage Rotator
- 12 / 24v Rotary
- 12 / 24v Oscilasers
- Synchronised rotators to suit ECE65
- Airport rotator 12v motor 24v bulb

Halogen Warning

- Small alternating lights
- Large alternating lights

Strobe Heads

- 360 degree Strobe Double Flash 12/24v
- Large Linear Strobe
- Small Linear Strobe
- Small Rectangular Strobe

Strobe Power Supply

- 2 output 40 watt supply
- 2 / 4 output 60 watt supply
- 2 / 4 output 75 watt supply
- 2 / 4 / 6 output 75 watt supply
- 2 / 4 / 6 output 90 watt supply

Signs & Grilles

- Centre sign
- Flashing STOP sign

LED's

- LEDX 12 / 24v single head LED's

Infosigns

- 45mm 1 / 2 message or police messages only

Speakers

- 60 Watt (raised centre required)
- 100 Watt low profile speaker (No raised centre required)

Spot / Flood Lighting

- 2 / 4 Alley Lights

Camera Bracket

- Bracket kit for mounting ANPR camera

Roof Connector

- 15 metres of cable with male and female connections





The Industry's Most Popular Lightbar

Height: 130mm (5") Width: 290mm (11.4") Length: up to 1741mm (68")

- Exceptional light output with a combination of 360° and standard LED options
- Gear driven halogen rotators for long life
- Easy maintenance, quick release one piece lenses
- UV stabilised polycarbonate lens

E11 Approved to regulation ECE65 - Halogen only

e11 Approved to automotive EMC directive 95/54/EC



Roof connector



Optional bespoke lettering and logo's available for all Premier Hazard lightbar illuminated centre sections.



Wind Tunnel Tested 130mph 208kph

For Mount Kit Options and for Common Lightbar Spares see pages 18-19

Lengths

- Available Lengths: 510mm (20"), 694mm (27"), 849mm (33"), 1036mm (41"), 1114mm (44"), 1214mm (48"), 1374mm (54"), 1476mm (58"), 1741mm (68")

- Available Colours:
 - Amber
 - California Blue
 - Clear
 - E11 Blue
 - Green
 - Red

Options

Rotator Assemblies

- 12 / 24v Rotator
- 12 / 24v Rotary
- Synchronised rotators to suit ECE65
- Airport rotator 12v motor 24v bulb
- Dual Voltage Rotator
- 12 / 24v Oscilasers

Halogen Warning

- Small alternating lights
- Large alternating lights

Strobe Heads

- 360 degree Strobe Double Flash 12/24v
- Large Linear Strobe
- Large Rectangular Strobe
- Small Rectangular Strobe
- Round Strobe
- Small Linear Strobe

Strobe Power Supply

- 2 output 40 watt supply
- 2 / 4 output 60 watt supply
- 2 / 4 output 75 watt supply
- 2 / 4 / 6 output 75 watt supply
- 2 / 4 / 6 output 90 watt supply

Signs & Grilles

- Centre sign
- Flashing STOP sign
- Speaker Grille

LED's

- LEDX 12 / 24v single head LED's
- 360 degree LED's
- PH34 LED directional light
- PH37 LED directional light
- PH46 LED directional light

Infosigns

- 45mm 1 / 2 message or police messages only
- 60mm 2 / 3 message or police messages only
- 75mm 3 / 10 message or any messages required
- 90mm 10 / 30 / 99 message or police messages required
- 90mm programmable software available

Speakers

- 60 Watt
- 100 Watt

Spot / Flood Lighting

- 2 / 4 Alley Lights
- Spot / Flood Lights

Camera Bracket

- Bracket kit for mounting ANPR camera

Roof Connector

- 15 metres of cable with male and female connections



The Ultimate in Lightbar Versatility

Height: 140mm (5.5") Width: 330mm (13") Length: up to 2540mm (100")

- Lens sections allowing a combination of lens colours along the length of the bar both front and rear
- Halogen, LED and strobe options available
- Gear driven rotators for long life
- Rotators wired in pairs
- UV stabilised polycarbonate lenses

E11 Approved to regulation ECE65 - Halogen only

e11 Approved to automotive EMC directive 95/54/EC



Roof connector



Optional bespoke lettering and logo's available for all Premier Hazard lightbar illuminated centre sections.



Wind Tunnel Tested 130mph 208kph

For Mount Kit Options and for Common Lightbar Spares see pages 18-19

Lengths

- Available Lengths: 255mm (10"), 390mm (15"), 510mm (20"), 630mm (25"), 750mm (30"), 870mm (34"), 990mm (39"), 1110mm (44"), 1230mm (48"), 1350mm (53"), 1470mm (58"), 1590 (63"), 1710mm (67"), 1830mm (72"), 1950mm (77"), 2070mm (82"), 2190mm (86"), 2310mm (91"), 2540mm (100")

- Available Colours:
 - Amber
 - California Blue
 - Clear
 - E11 Blue
 - Green
 - Red

Options

Rotator Assemblies

- 12 / 24v Rotator
- 12 / 24v Rotary
- Synchronised rotators to suit ECE65
- Airport rotator 12v motor 24v bulb
- Dual Voltage Rotator
- 12 / 24v Oscilasers

Halogen Warning

- Small alternating lights
- Large alternating lights

Strobe Heads

- 360 degree Strobe Double Flash 12/24v
- Large Linear Strobe
- Large Rectangular Strobe
- Small Rectangular Strobe
- Round Strobe
- Small Linear Strobe

Strobe Power Supply

- 2 output 40 watt supply
- 2 / 4 output 60 watt supply
- 2 / 4 output 75 watt supply
- 2 / 4 / 6 output 75 watt supply
- 2 / 4 / 6 output 90 watt supply

Signs & Grilles

- Centre sign
- Speaker Grille
- Flashing STOP sign

LED's

- LEDX 12/24v single head LED's
- 360 degree LED's
- PH34 LED directional light
- PH46 LED directional light

Infosigns

- 45mm 1 / 2 message or police messages only
- 60mm 2 / 3 message or police messages only
- 75mm 3 / 10 message or any messages required
- 90mm 10 / 30 / 99 message or police messages required
- 90mm programmable software available

Speakers

- 60 Watt
- 100 Watt

Spot / Flood Lighting

- 2 / 4 Alley Lights
- Spot / Flood Lights

Camera Bracket

- Bracket kit for mounting ANPR camera

Roof Connector

- 15 metres of cable with male and female connections



Height: 117mm (4.6") Width: 290mm (11.4") Length: up to 1500mm (60")

- Lightweight
- Low cost
- Polycarbonate base with aluminium support channel strips
- UV stabilised polycarbonate lenses
- Quality components
- Easy maintenance, quick release one piece lenses

E11 Approved to regulation ECE65 – Halogen Amber and Blue- Xenon Blue only

e11 Approved to automotive EMC directive 95/54/EC



Emax options

- Amber only
- Illuminated or plain centre
- 2 or 4 modules
- 29" (794mm), 49" (1245mm), 59" (1498mm) lengths
- Halogen, Xenon or LED light source
- Stop/ Tail/ Indicators
- Floodlights
- Optional lettering



Optional bespoke lettering and logo's available for all Premier Hazard lightbar illuminated centre sections.



Wind Tunnel Tested 130mph 208kph

For Mount Kit Options and for Common Lightbar Spares see pages 18-19

Arrowbars to suit a wide range of applications

Traffic direction at the touch of a button with sizes ranging from 965mm (38") to 1194mm (47")



Height: 94mm Length: 965mm Depth: 70mm Weight: 4.5kg

AB-8L-38 Arrowbar

- Suitable for the smaller appliances -only 965mm long
- 12v only halogen heads
- Colours: Amber, blue & amber/blue
- Various warning patterns



Height: 68mm Length: 973mm or 1195 Depth: 110mm Weight: 6kg

Arrowstick

- Available in two lengths with either 8 or 10 light heads
- 12v or 24v halogen heads
- Various warning patterns

Arrowstick Options

AS-839	990mm, 8 lamp Arrowstick complete with standard controller
AS-847	1195mm, 8 lamp Arrowstick complete with standard controller
ASB-C	Standard Arrowstick controller 12v or 24v
ASD-C	Deluxe Arrowstick controller 12v or 24v

Spare Parts

550930	28v 32v for A5839-847
--------	-----------------------



8700 Controller

- Compact design
- Rotary switch controls arrow patterns
- LED's indicate flash pattern on selected
- Arrow patterns: left arrow/right arrow centre out/flashing blocks
- Fast/slow flash speed control
- High/low light intensity
- 12v



ASD-C Deluxe Controller

All the features of the standard controller plus-fast/slow speed control high/low light intensity auxiliary switch.

ASB-C Standard Controller

- Standard controller included with Arrowstick
- LED's indicate flash pattern selected
- Standard flash pattern: left arrow/right arrow centre out/flashing blocks

Slimline LEDX™ Narrowsticks Not for use in the UK

NASL847

Length 990.06mm & 1193.8mm Height 44.45mm Depth 69.85mm Weight 2.8kgs



The newest member of our innovative Arrowstick family of traffic direction products – **only 40mm tall.**

NASL839RB



- Versatile mounting options
- Basic control head included
- Current draw 4 amp average

Height: 130mm (4.4") Width: 205mm (8.2") Length: 420mm (16.5")

- UV stabilised polycarbonate lenses
- Flexible magnetic mounting with additional suction suitable for curved or flat roofs, Halogen only
- Colours: Amber, blue, clear, green, magenta & red (magenta not approved for European use at time of publication)
- Single voltage application:
 - 12v rotators 55w bulb @ 4.5 amps
 - 24v rotators 70w bulb @ 3.0 amps



Weight: 1.3kg

Approved to Regulation ECE65 – Halogen only | Approved to EMC directive 95/54/EC

9420 Four bolt fixing

Popular Models

E9420-H-12-A	halogen, 12v, amber
E9420-H-12-B	halogen, 12v, blue
E9420-H-12-EB	halogen, 12v, E blue
9420-H-12-C	halogen, 12v, clear
9420-H-12-G	halogen, 12v, green
9420-H-12-M	halogen, 12v, magenta
9420-H-12-R	halogen, 12v, red

Also available in 24V **9420-H-24-A**

9490BM Single bolt fixing

Popular Models

E9420BM-H-12-A	halogen, 12v, amber
9420BM-H-12-B	halogen, 12v, blue
E9420BM-H-12-EB	halogen, 12v, E blue
9420BM-H-12-C	halogen, 12v, clear
9420BM-H-12-G	halogen, 12v, green
9420BM-H-12-M	halogen, 12v, magenta
9420BM-H-12-R	halogen, 12v, red

 **Magnetic Mount Beacons**
These magnetic beacons are intended for temporary use and may detach at speeds above those indicated.



Weight: 2.64kg

Approved to Regulation ECE65 – Halogen only | Approved to EMC directive 95/54/EC

9420MBR Magnetic mount

Popular Models

E9420MBR-H-12-A	halogen, 12v, amber
9420MBR-H-12-B	halogen, 12v, blue
E9420MBR-H-12-EB	halogen, 12v, E blue
9420MBR-H-12-C	halogen, 12v, clear
9420MBR-H-12-G	halogen, 12v, green
9420MBR-H-12-M	halogen, 12v, magenta
9420MBR-H-12-R	halogen, 12v, red

Also available in 24V **9420MBR-H-24-A**



Weight: 2.3kg

Approved to EMC directive 95/54/EC

Dual voltage strobe

9492 Four bolt fixing/dual voltage

Popular Models

9492-S-DV-A	strobe, 12/24v, amber
9492-S-DV-B	strobe, 12/24v, blue
9492-S-DV-C	strobe, 12/24v, clear
9492-S-DV-G	strobe, 12/24v, green
9492-S-DV-M	strobe, 12/24v, magenta
9492-S-DV-R	strobe, 12/24v, red

Height: 125mm (5") Width: 268mm (10.5") Length: 394mm (15.4")

- UV stabilised polycarbonate lenses
- Heavy duty nickel coated magnets & rubber covers
- Colours: Amber, blue, clear, green & red



Weight: 2kg

Approved to EMC directive 95/54/EC

9200 Four bolt fixing

Popular Models

9200-H-12-A	halogen, 12v, amber
9200-H-12-B	halogen, 12v, blue
9200-H-12-EB	halogen, 12v, E blue
9200-H-12-C	halogen, 12v, clear
9200-H-12-G	halogen, 12v, green
9200-H-12-R	halogen, 12v, red

Also available in 24V eg **9200-H-24-A**

Current draw 12v 9amp
24v 6amp



Weight: 3kg

Approved to EMC directive 95/54/EC

9200M Magnetic mount

Popular Models

9200M-H-12-A	halogen, 12v, amber
9200M-H-12-B	halogen, 12v, blue
9200M-H-12-EB	halogen, 12v, E blue
9200M-H-12-C	halogen, 12v, clear
9200M-H-12-G	halogen, 12v, green
9200M-H-12-R	halogen, 12v, red

Also available in 24V eg **9200M-H-24-A**

Current draw 12v 9amp
24v 6amp

 **Magnetic Mount Beacons**
These magnetic beacons are intended for temporary use and may detach at speeds above those indicated.



Weight: 3kg

Approved to EMC directive 95/54/EC

9295DM Magnetic with cigar connector & lead

Popular Models

9295DM-HS-12-A	halogen-strobe, 12v, amber
9295DM-HS-12-B	halogen-strobe, 12v, blue
9295DM-HS-12-C	halogen-strobe, 12v, clear
9295DM-HS-12-G	halogen-strobe, 12v, green
9295DM-HS-12-R	halogen-strobe, 12v, red
9295D-HS-12	without cigar connector & lead

Current draw 12v 11amp
24v 9amp



Weight: 2kg

Approved to EMC directive 95/54/EC

9222 Four bolt fixing

Popular Models

9222-H-12-A	halogen, 12v, amber
9222-H-12-ARI	halogen, 12v, amber/red inserts
9222-H-12-B	halogen, 12v, blue
9222-H-12-BRI	halogen, 12v, blue/red inserts
9222-H-12-EB	halogen, 12v, E blue
9222-H-12-C	halogen, 12v, clear
9222-H-12-G	halogen, 12v, green
9222-H-12-GRI	halogen, 12v, green/red inserts
9222-H-12-R	halogen, 12v, red

Also available in 24V eg **9222-H-24-A**

Current draw 12v 15amp
24v 12amp

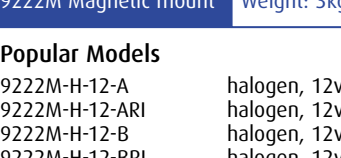

Weight: 3kg

9222M Magnetic mount

Popular Models

9222M-H-12-A	halogen, 12v, amber
9222M-H-12-ARI	halogen, 12v, amber/red inserts
9222M-H-12-B	halogen, 12v, blue
9222M-H-12-BRI	halogen, 12v, blue/red inserts
9222M-H-12-EB	halogen, 12v, E blue
9222M-H-12-C	halogen, 12v, clear
9222M-H-12-G	halogen, 12v, green
9222M-H-12-GRI	halogen, 12v, green/red inserts
9222M-H-12-R	halogen, 12v, red

Also available in 24V eg **9222M-H-24-A**

Current draw 12v 15amp
24v 12amp

Traffic Max

ULTRA Low Profile All LED Lightbar

The Traffic Max features an incredibly bright light output, using low power consumption & latest generation LED's in an ultra-sleek, strong design.

Height: 53mm (2.1") Width: 311mm (12.25") Length: up to 1070mm (42")



- Exceptional light output, using latest generation LED's
- Low Amp draw
- Extruded aluminum frame
- Clear Polycarbonate lenses
- Available in flashing or Steady-Burn versions
- Ultra-low profile
- Mounting kits available separately

e11 Approved to automotive
EMC directive 95/54/EC

Weight: 12.7kg

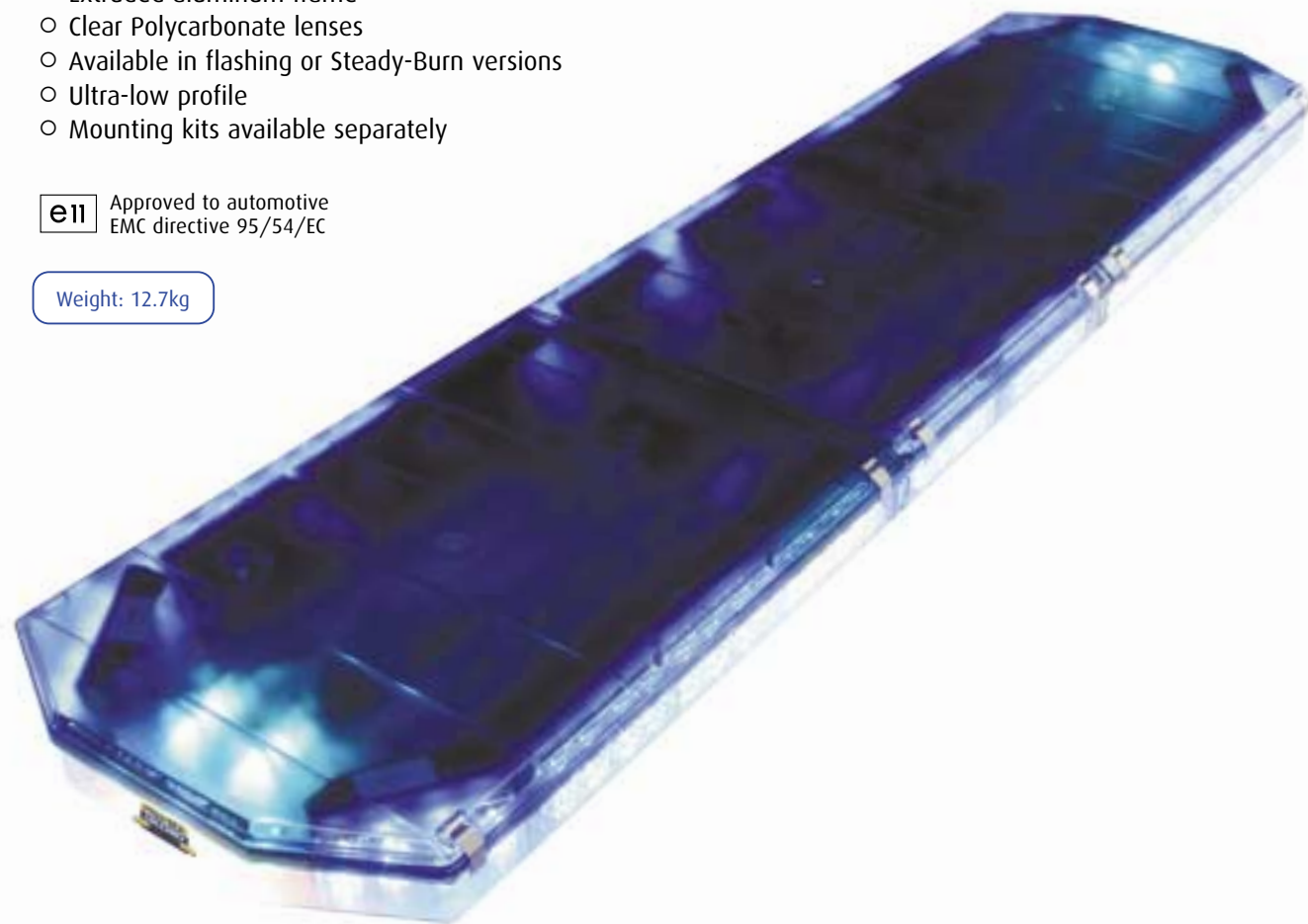

MX 7000

The Shape You Can Trust

There's nothing like the dual-decks of the MX7000™ for giving you the power and flexibility to get everything you want from a performance lightbar. You get primary unobstructed signal protection from upper-deck rotators and mirrors, while the lower-deck is dedicated to providing a variety of special purpose lights- including the highly acclaimed built-in Arrowstick®.

Height: 146mm (5.75") Width: 311mm (12.25") Length: up to 1752mm (69")



- Extruded aluminum frame
- Polycarbonate lenses
- Amber or clear lens with filter options
- H1 55 watt Halogen rotating assemblies
- Mounting kits sold separately

e11 Approved to automotive
EMC directive 95/54/EC

Weight: 18kg





Lomax & Midimax



30850*	End lens (specify colour and length) & inserts
30870*	Centre lens (specify colour and length) & inserts
306104	Bridge Moulding (Black)
306113	Bridge Moulding (Amber)
306118	Bridge Moulding and Divider
306120	Bridge Moulding Seal
306401K	End Moulding Kit
306402K	End Moulding (Midimax- No alley Lights)
306403K	End Moulding (Midimax- Alley Lights)
306706	Lens Strap
305309	Blind Rivet (Lens fastener)
306401	End Moulding
202711	Label - end plate UK (Lomax)
202713	Label - end plate UK (Midimax)

Optimax & Hi-max



3060**	End lens (specify colour and length) & inserts
30650*	Centre lens (specify colour and length) & inserts
306101	Bridge Moulding and Divider
306102	Bridge Moulding (Amber)
306201	Bridge Moulding Seal
306401	End Moulding (Optimax)
306401K	End Moulding Kit (Optimax)
306402K	End Moulding (Hi-max)
306403K	End Moulding (Hi-max- Alley lights)
902400A	Alley light 26° Left Hand
902401A	Alley light 26° Right Hand
306706	Lens Strap
305309	Blind Rivet (Lens fastener)
306401	End Moulding
202704	Label - end plate UK (Optimax)
202712	Label - end plate UK (Hi-max)

Maxim



30040*	End Cap (specify colour) & inserts
30030*	Centre lens (specify colour and length) & inserts
300800	Lens to lens seal
300700	End Cap seal
300600	Divider
301100	Support Pillar
101900	Rod - lens locking
200000	Label - end plate UK

Minimax



302004	Amber lens
302002	Blue lens
302002E	E blue lens
302000	Clear lens
302005	Green lens
302007	Opal lens
302003	Red lens

Ultimax



30900*	Upper end lens (specify colour)
30910*	Upper centre lens (specify colour)
30940*	Lower end lens (specify colour)
309218*	Lower end side lens (specify colour)
30920*	Lower centre lens (specify colour and length) & inserts
308606B	Upper divider Black
308606A	Upper divider Amber

Aeromax



802710	Amber lens
802720	Blue lens
802721	E blue
802725	Clear lens
802730	Green lens
802715	Red lens

Magnetic Mounts

507030	Cigar plug
501801	Heavy duty cigar plug
103600	Nickel coated magnet
301600	Rubber cover

Emax



13562.00	12v rotator (2 module bar)
13562.01	24v rotator (2 module bar)
13589.00.12v	2v rotator (4 module bar)
13589.00.24v	24v rotator (4 module bar)
13551.04	12/24v inner rotator (4 module bar)
13590.00	12/24v inner rotator (4 module bar ECE Reg 65)
10519.22	Outer lens (2 module bars)
10518.22	Outer lens 1250/1500mm Recovery bars & 1250mm 4 module bar
10518.21	Outer lens 1250mm ECE Reg 65 bars
12345.03	Centre section 750mm bar
12345.01	Centre section 1250mm (2 module bar) & 1500mm Recovery bar
12345.02	Centre section 1250mm (Recovery & 4 module bars)
12345.00	entre section 1500mm bar
12342.00	Bridge piece
H448	12v rotator bulb
H446	24v rotator bulb
L382	12v centre section bulb
L241	4v centre section bulb

Rotator Assemblies



900600	12v rotator assembly
900700	24v rotator assembly
900704	Airport Authority Rotator assembly
900600D	12v dual rotator assembly no1 ECE65
900600DNM	12v dual rotator assembly no 2 ECE65 (no motor)
900700D	24v dual rotator assembly no1 ECE65
900700DNM	24v dual rotator assembly no2 ECE65 (no motor)
306106-C	C Belt for ECE65 assemblies
900750	Dual voltage rotator assembly complete with 12v bulb
900201	12v motor only
900301	24v motor only
300000	Worm drive
100500	Bulb clip
900900	Stat light 12V
901000	Stat light 24V
901200	Bracket & Bearing assembly
306103-C	Reflector Only

Spare Bulbs

550100	H1 halogen 12v 55watt
550200	H1 halogen 24v 70watt
550801	H2 halogen 12v 55watt
550800	H3 halogen 12v 55watt
550900	H3 halogen 24v 70watt
550905	12v 20watt for R43 clear only
550906	24v 20watt for R43 all colours
550907	12v 35watt for R43 coloured only
559640	12v alley light (Lomax, Optimax & Maxim)
559642	24v alley light (Lomax, Optimax & Maxim)
559644	12v alley light (Midimax & Hi-max)
559646	24v alley light (Midimax & Hi-max)
550401	Bulb holder & bracket for cruise light & illuminated centre
550500	12v Incandescent bulb
550700	24v Incandescent bulb

Mirrors

101200L	Large "V" mirror (Lomax)
101004L	Mirror single sided - left (Midimax)
101004R	Mirror single sided - right (Midimax)
101500	Small "V" mirror (Midimax)
101600	Large "V" mirror (Midimax)
101000	Flat mirror (Optimax, Maxim & Hi-max)
101100	Small "V" mirror (Optimax, Maxim & Hi-max)
101200	Large "V" mirror (Optimax, Maxim & Hi-max)
112413	Rotary mirror (Optimax, Maxim & Hi-max)

Strobe Assemblies



800300	Fresnel lens clear 100mm for 360° strobe
800300L	Fresnel lens clear 75mm for 360° strobe
610000	1204 PCB assembly for self contained 360° strobe 12v
610100	1204 PCB assembly for self contained 360° strobe 24v
112609	R43 bracket vertical mount
112643L	R43 bracket horizontal mount L/H
112643R	R43 bracket horizontal mount R/H
104400	Bracket for PAR36 to fit into lightbar
112602	Bracket for RECT46 to fit into lightbar
113002	Bracket L/H for linear 157x70mm
113003	Bracket R/H for linear 157x70mm

Strobe tubes & sealed beam

551100	9173 strobe tube (octal tube)
906400	Plugs & pins kit
558800	Strobe tube
559000	Strobe trigger for above
553400	PAR36 strobe sealed beam (clear)
553210	RECT46 strobe sealed beam (clear)
551105	Linear strobe upper deck
840161	Linear strobe lower deck

LED's

LEDX™	12V Amber	24V Amber
	12V Blue	24V Blue
	12V Red	24V Red
PH34 LED	12V Amber	
	12V Blue	
	12V Red	
PH46 LED	12V Amber	
	12V Blue	
	12V Red	

Mount Kits

9BK-20	Permanent Mount 20mm depth
9BK-40	Permanent Mount 40mm depth
9BK-60	Permanent Mount 60mm depth
9PK	Permanent raised Mount
9HK	Hook on Mount
9GK	Gutterless Mount
9RK	Roof clamp Mount
9UK	Round U clamp kit
9SK	Square U clamp kit
LBQDIS	Roof connector loom





LED's the Future

The slimline, low weight nature of LED's opens up a wide range of design and installation opportunities for all types of vehicle.

The high intensity of LED light is an added bonus for the emergency utility services, as it increases the warning of a hazard to other road users.

Benefits:

- Low energy draw giving minimal drain on vehicle battery
- 'Fit & Forget' No bulbs to change
- Totally sealed against water and dust ingress
- 100,000 hours service life
- 5 year warranty
- Ideal for covert and directional lighting
- Approved to EMC 95/54/EC

Single LEDX

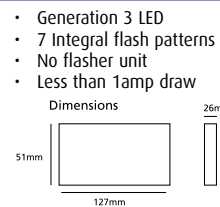

- Generation 3 LED
- 7 Integral flash patterns
- No flasher unit
- Less than 1amp draw

Popular Models

- LXEX1F-A Single head Alum. base Amber
- LXEX1F-B Single head Alum. base Blue
- LXEX1F-R Single head Alum. base Red
- LXEXB1F-A Single black Alum. base Amber
- LXEXB1F-B Single black Alum. base Blue
- LXEXB1F-R Single black Alum. base Red

Double LEDX

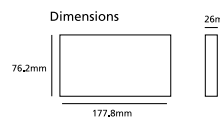

- Generation 3 LED
- 7 Integral flash patterns
- No flasher unit
- Less than 1amp draw

Popular Models

- LXEX2F-AA Double head alum. base Amber/ Amber
- LXEX2F-AB Double head alum. base Amber/ Blue
- LXEX2F-AR Double head alum. base Amber/ Red
- LXEX2F-BB Double head alum. base Blue/ Blue
- LXEX2F-BR Double head alum. base Blue/ Red
- LXEX2F-RR Double head alum. base Red/ Red
- LXEXB2F-AA Double head black base Amber/ Amber
- LXEXB2F-AB Double head black base Amber/ Blue
- LXEXB2F-AR Double head black base Amber/ Red
- LXEXB2F-BB Double head black base Blue/ Blue
- LXEXB2F-BR Double head black base Blue/ Red
- LXEXB2F-RR Double head black base Red/ Red

LEDX Mounting Options



Popular Models

- LXEX90 90 degree bracket
- LXEXSHD black shroud

PH461



- Generation 2 LED
- Flasher unit required
- 6x4 (168x107mm) LED Lamp
- Colours Blue, red, amber
- 12v and 24v

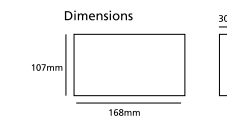

Popular Models

- PH461ENOA-12 12v amber
- PH461ENOB-12 12v blue
- PH461ENOR-12 12v red
- PH461PPH Chrome bezel for surface mounting

For 24 volt order AM05 voltage Converter

PH34



- Generation 2 LED
- Clear Lens
- 3x4 (80x90mm) LED lamp with moulded housing
- 12v only

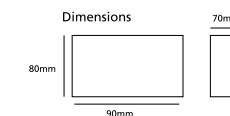

Popular Models

- PH34NENB-A-C/ Amber behind clear lens
- PH34NENB-R-C/ Red behind clear lens
- PH34NENB-R-C/ Blue behind clear lens

Wing Repeater



- LED lamp, surface mounted plastic housing with clip in, fully sealed, lens module
- Black housing with clear lens module
- Available with Blue, red or Amber high intensity LED
- Various flash patterns selectable at installation
- Pairs of lamps can be synchronised
- Low current draw, 0.1 amp at 12v

Length: 700mm Width: 50mm Height: 20mm

Approvals applied for

24V Voltage Converter

Some LED directional lights in 24 volt may require a voltage converter. Order part no. AM05

Housing for LED Part Numbers

- PH461PPH For 461 series
- PH341PPH Chrome Bezel for PH34 series
- PEHB34 Bumper Mount for PH 34 series Black
- PEHC34 Bumper Mount for PH 34 series Chrome
- PH34NEB Surface mount bezel





LED's the Future

LED Visor Light



- Sixteen flash patterns
- Clear outer lens reduces profile for covert applications
- Compact size provides clear line of vision
- Front display shows flash pattern in use
- Last flash pattern recall at power-up
- Driver and Passenger side On/Off controls
- 10-16VDC, input voltage range (Interior use only)

Approvals applied for

Width: 123mm Depth: 30mm Length: 310mm Weight: 0.44kg

Popular Models

ETVLED* (*indicate colour choice A-Amber, B-Blue etc)

Perimeter Light



- 20 flash patterns including WIG-WAG patterns
- Low amp draw
- Impervious to vibration
- Unique triple stack housing available
- 7" x 3" / 76.2mm x 177.8mm

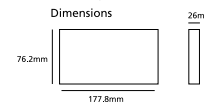

Popular Models

- C3-45 AH Amber
- C3-45 BZA Bezel, Amber
- C3-45 R Red
- C3-45 BZR Bezel, Red
- C3-45 W White
- C3-45 BZW Bezel, White

Perimeter Light



- 20 flash patterns including WIG-WAG patterns
- Low amp draw
- Impervious to vibration
- Unique triple stack housing available
- 6" x 4" / 101.6mm x 152.4mm

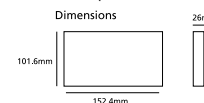

Popular Models

- C3-65 AH Amber
- C3-65 BZA Bezel, Amber
- C3-65 R Red
- C3-65 BZR Bezel, Red
- C3-65 W White (includes option for steady burn reverse light)
- C3-65 BZW Bezel, White (includes option for steady burn reverse light)

Perimeter Light



- 20 flash patterns including WIG-WAG patterns
- Low amp draw
- Impervious to vibration
- 9" x 7" / 177.8mm x 228.6mm

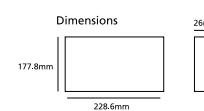

Popular Models

- C3-85 AH Amber
- C3-85 BZA Bezel, Amber
- C3-85 R Red
- C3-85 BZR Bezel, Red
- C3-85 W White
- C3-85 BZW Bezel, White

Economy LED



- Surface mount with no hole cutting required
- Available in red, blue, amber or white
- User selectable multiple flash patterns available
- Can be steady burned and then hooked to an external flasher

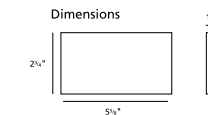

Popular Models

- LCB25A Amber LED black Housing
- LCB25B Blue LED black Housing
- LCB25R Red LED black Housing
- LCB25W White LED black Housing
- LCB25A Amber LED black Housing
- LCB25B Blue LED black Housing
- LCB25R Red LED black Housing
- LCB25W White LED black Housing

Economy LED



- Surface mount with no hole cutting required
- Available in red, blue, amber or white
- User selectable multiple flash patterns available
- Can be steady burned and then hooked to an external flasher

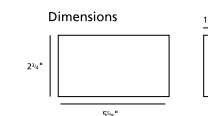

Popular Models

- LCB25A Amber LED black Housing
- LCB25B Blue LED black Housing
- LCB25R Red LED black Housing
- LCB25W White LED black Housing
- LCB25A Amber LED black Housing
- LCB25B Blue LED black Housing
- LCB25R Red LED black Housing
- LCB25W White LED black Housing

Slimline LEDX™ Narrowsticks Not for use in the UK

NASL847

Length 990.06mm & 1193.8mm Height 44.45mm Depth 69.85mm Weight 2.8kgs



The newest member of our innovative Arrowstick family of traffic direction products - **only 40mm tall.**

NASL839RB

Length 990.06mm & 1193.8mm Height 44.45mm Depth 69.85mm Weight 2.8kgs



- Versatile mounting options
- Basic control head included
- Current draw 4 amp average

24V Voltage Converter

Some LED directional lights in 24 volt may require a voltage converter. Order part no. **AM05**

Housing for LED Part Numbers

- PH461PPH For 461 series
- PH341PPH Chrome Bezel for PH34 series
- PEHB34 Bumper Mount for PH 34 series Black
- PEHC34 Bumper Mount for PH 34 series Chrome
- PH34NEB Surface mount bezel





- Premier Hazard offers the Emergency Services a range of covert equipment ideal for unmarked vehicles.
- Covert strobe, lighting kits and lenses

Covert Kits R105 S



- Covert strobe tube
- Colours: Blue, clear, green, red and amber
- Dual voltage

Popular Models

2CS-B	2 x R105-B Strobe tubes blue 1 x PHS240-P 2 Output, 40w power supply
2CS-C	2 x R105-C Strobe tube clear 1 x PHS240-P 2 Output, 40w power supply
2CS-G	2 x R105-G Strobe tube green 1 x PHS240-P 2 Output, 40w power supply
2CS-R	2 x R105-R Strobe tubes red 1 x PHS240-P 2 Output, 40w power supply
RI05-C	Covert strobe clear
RI05-*	Covert strobe coloured

LEDX™ Deck & Grille Lights L



- Small and unobtrusive Unit
- Single module has four patterns, selected with internal jumpers; double Module has 21 patterns
- Draws less than 1amp of power from the battery
- 10-16v DC operation
- Suction cup mounting kit included, other mounting option available
- Also available in Dual head option

Width: 122mm Depth: 70mm Height: 44.5mm

Approved to automotive EMC directive 95/54/EC

Popular Models

LX1F-X	1 Head Flashing Red, Blue or Amber
LX2F-X	2 Head Flashing Red, Blue or Amber
LX1HOOD	Hood for LX1 unit
LX2HOOD	Hood for LX2 unit

880 Beacon H



Weight: 1kg

Approved to Regulation ECE65 - Halogen only

Approved to automotive EMC directive 95/54/EC

- Compact, powerful halogen rotating beacon c/w magnetic mount, coil lead and cigar socket
- Clip on multi-flash mirror giving 800 forward flashes per minute not ECE65 approved
- Universal bracket with adhesive pad
- 12v or 24v
- Colours: amber, blue, E-blue, clear, green, red
- Current draw 12v 4.5amp
24v 2 amp

Popular Models

880DM-12-A	1 x 880M-H-12-A 1 x 8FL 1 x 8KT	12v Amber beacon Multi-flash mirror Universal Bracket
880DM-12-B	1 x 880M-H-12-B 1 x 8FL 1 x 8KT	12v Blue beacon Multi-flash mirror Universal Bracket
880DM-12-R	1 x 880M-H-12-R 1 x 8FL 1 x 8KT	12v Red beacon Multi-flash mirror Universal Bracket

Deck Blaster S H



Weight: 1kg

Approved to automotive EMC directive 95/54/EC

- Lightweight design
- Alternating or steady burn halogen
- Multi pattern strobe
- Colours: Amber, blue, clear, red
- Dual colour lens capability
- 12v only
- Various mounts and a windscreen hood available

Popular Models

800	Alternating halogen (specify colour)
805	Multi pattern strobe (specify colour)
810	Halogen switchable steady/off/flash (specify colour)
820	Halogen steady burn (specify colour)
DBBOOT	Windscreen hood
HLMNT	Velcro mount kit
SCMNT	Suction-cup mount kit
RDMNT	Rear deck mount Kit

Visor Light S H



Width: 123mm Depth: 30mm Length: 310mm Weight: 0.44kg

- Lightweight construction and easy to fit
- Alternating halogen or Four flash Strobe
- 12v only
- Colours: Amber, blue, clear, green, red
- Mixed colours available

Does not Conform to EMC Directive 95/54 EC for electromagnetic compatibility

Popular Models

V275	Alternating halogen 12v (specify colour)
V440	Four flash strobe 12v (specify colour)

LED Visor Light L



Width: 123mm Depth: 30mm Length: 310mm Weight: 0.44kg

- Sixteen flash patterns
- Clear outer lens reduces profile for covert applications
- Compact size provides clear line of vision
- Front display shows flash pattern in use
- Last flash pattern recall at power-up
- Driver and Passenger side On/Off controls
- 10-16VDC, input voltage range (Interior use only)

Approvals applied for

Popular Models

ETVLED*	(*indicate colour choice A-Amber, B-Blue etc)
---------	---

R431 S



- Moulded housing
- Clear outer lens
- Internal strobe bulb in blue or red
- Dual voltage
- Universal mount

Popular Models

R432-S-C/B	Covert blue halogen head
R431-S-C/R	Covert red halogen head

1000 S



- Moulded housing
- Internal filter in blue or red
- Clear outer lens and metal diffuser
- 12v or 24v
- Universal mount
- Complete with 2.5m strobe cable

Popular Models

2CH1000-H-B	2 x 1000H-12-CB 12v covert blue 1 x ETAF08-12P halogen flasher unit
2CS1000-S-B	2 x 1000S-CB Covert blue 1 x PHS240-P 2 Output, 40w power supply

H Halogen S Strobe L LED



- Amplifiers incorporate surface mount technology and MOSFET power amplifiers
- Reverse polarity protection – without blowing fuse
- Low volume siren test (7009,7109)
- Siren interlock that will switch off siren if beacon fails
- Safety shutdown in case of over heating or short circuit due to speaker failure
- Fault indicator
- All sirens fitted with cooling fan except 6002
- Tones can be controlled through horn push
- Approved to Class 1 for Home Office VIDG and can be programmed to any requirement or country specification.

e11 Approved to automotive EMC directive 95/54/EC
Approved to automotive EMC directive 97/24/EC (chapter 8 for motorcycles)

7004 Remote Mount Siren



Width:149mm Height:48mm Depth:169mm Weight:1.46kg

- Compact siren – 5 tone options
- Tones can be controlled through horn push

Standard tones: Wail, Yelp, Hi Lo, Air Horn, Pulsar
Requires separate switch panel

OPTIONAL HIGH POWER

Traffic Alert



Control Unit
Dimensions: 175mm x 86mm Depth: 16mm



e11 Approved to automotive EMC directive 95/54/EC

- Serial control for Lightbar, siren and auxiliary lighting
- Arrowstick® switch control 3999
- Automatic short circuit connection
- Handbrake input for both lighting & siren
- Timed output ('C' button)
- Plug-in microphone
- 100 watt rating

Standard tones: Wail, Yelp, HyperYelp, Hi-Lo, Hyper Lo, Air Horn

OPTIONAL RECORDED SPEECH

Popular Models

- 3997 Basic RLS Siren with Arrowstick Control
- 3998 Basic RLS Siren without Arrowstick Control
- 3999 Basic RLS Siren with Arrowstick & Spotlight Control
- Built-in walk-around self testing function
- XTRAMP2 Additional Amp for any of the above sirens



Width:149mm Height:48mm Depth:169mm Weight:1.46kg

7006 Remote Mount Siren and PA

7006-12 12V
7006-24 24V

- 4 tone options remote mount amplifier
- Full PA facility
- Plug-in microphone with modular connections
- Toggle button on microphone controls tones

Standard tones: Wail, Yelp, Hi Lo, Air Horn

OPTIONAL HIGH POWER



Width:149mm Height:48mm Depth:169mm Weight:1.46kg

7007 Remote Mount Siren and PA

7007-12 12V
7007-24 24V

- 5 tone options remote mount amplifier
- Full PA facility
- Plug-in microphone with modular connections

Standard tones: Wail, Yelp, Hi Lo, Air Horn, Pulsar

OPTIONAL HIGH POWER

OPTIONAL RECORDED SPEECH



502 504 509 509A

Switch Panels for use with 6002/7004 Sirens

- 502 Discreet toggle switch (2 tones)
- 504 Dash or flush mount rocker switch (2 tones)
- 509 Dash or flush mount rocker switches (3 tones)
- 509A Dash or flush mount rocker switches with additional Air horn button (3 tones)



Width:149mm Height:48mm Depth:140mm Weight:1.76kg

7009 Dash Mount Siren and PA

7009-12 12V
7009-24 24V

- 5 tone options dash mount amplifier
- Full PA facility with plug-in microphone
- Radio re-broadcast
- Volume control
- Manual and Air horn button
- Tones can be controlled through horn push

Standard tones: Wail, Yelp, Hi Lo, Air Horn, Pulsar

OPTIONAL HIGH POWER

OPTIONAL RECORDED SPEECH



Width:149mm Height:48mm Depth:140mm Weight:1.76kg

7109 Dash Mount Siren and PA

- 5 tone options dash mount amplifier
- Full PA facility with plug-in microphone
- Three position switch for lightbar control
- Radio re-broadcast
- Volume control
- Manual and Air horn button
- Tones can be controlled through horn push

Standard tones: Wail, Yelp, Hi Lo, Air Horn, Pulsar

OPTIONAL HIGH POWER

OPTIONAL RECORDED SPEECH

OPTIONAL HIGH POWER Intended to drive two loudspeakers in parallel (200watts).

OPTIONAL RECORDED SPEECH Record and playback facility

8000 Series Siren

Speakers Kits & Technical Spec

The 8000 series is a modular approach to siren and light bar control.

8000 Series



Console
Dimensions: 160mm x 88mm Depth: 39mm
Weight: 285g



Power module
Dimensions: 208mm x 163mm Depth: 47mm
Weight: 800g

e11 Approved to EMC directive 95/54/EC

e11 Approved to directive 97/24/EC

All amplifiers

- Features:**
- Standby current meets automotive standard of less than 0.3 milliamps.
 - Low current Master Switch.
 - Custom designed heat sink assembly.
 - All models can drive 2 x 100 Watt loudspeakers over full temperature range.
 - Siren Running Output with current monitor facility.
 - Battery voltage monitor and shutdown.
 - Output power reduction to reduce power to loudspeaker.
 - High speed fan with controller.
 - Self resetting circuit fuses.
 - Faster short circuit performance.
 - More robust construction.
 - Relay output.
 - Sidelights input.

- Benefits:**
- Will not flatten battery, even over extended periods.
 - Economical switch can be used to disable system if desired.
 - Superior performance in tropical conditions.
 - Single model for standard (/T) and High Power (/H) applications.
 - Connects straight to Data Logger where required.
 - For added dependability, output is only present when loudspeaker operational.
 - Prevents operation of amplifier when battery voltage goes too high or too low. 12 volt amplifier will not be damaged if connected to 24 volts.
 - Avoids damage to loudspeaker when voltage rises due to fast charge or in the event of regulator malfunction.
 - Variable fan speed dependent on operating conditions.
 - Reduced down time for maintenance.
 - Greater protection for output transistors.
 - Less chance of damage in transit.
 - Control of one external function with simple addition of one relay.
 - Auto dimming of display indicators.

Basic amplifiers, 8004

- Features:**
- Run Input.

- Benefits:**
- **Universally compatible with alternative switching systems**

Amplifiers with audio facility, 8005

- Features:**
- Same amplifier for all applications.
 - State of the art Digital Signal Processor (DSP).
 - Digital audio amplifier.
 - CANBUS
 - Noise cancelling electret condenser microphone.
 - 20 second speech record facility.
 - Two auxiliary audio inputs.

- Available with 7000/8000 amplifier conversion loom. Pt no 507158 (7004 and 7007 only)**
- Reduced stock. Flexibility to change or add to system.
 - Low frequencies prevented which could damage loudspeaker.
 - Better sound reproduction.
 - Reliable intercommunication between modules with all the benefits of this automotive standard.
 - Clearer audio in Public Address mode under noisy conditions.
 - Standard in all amplifiers (use dependent on Control Panel).

Diagnostics

- Allows for multiple inputs on same application e.g. Broadcast Radio, Two way radio, MP3 player, Cassette player etc.
- Voltage, temperature and fault information available on suitable Control Panel.

Speaker Cows & Extension Kits



When ordering please note that the model numbers include the driver size and type of cowl. e.g. P100-S is a P100 speaker with an S cowl.

- C** Concealed speaker cowl for mounting behind grille or bumper
- F** Flared speaker cowl for roof mounting
- L** Lightbar cowl, for mounting in lightbars
- M** Medium cowl, for compact applications
- R** Round cowl for roof, behind grille or motorcycle mounting.
- S** Rectangular cowl for roof or behind grille mounting
- P16E** Extension kit for remote mounting of the driver from the cowl assembly (C, R & S cowls + M, L, F)

Speaker Drivers

- PA35 35w speaker driver (for use with 6002 amplifier) 2.35kg
- PA60 60w speaker driver 2.30kg
- PA100 100w speaker driver 2.80kg
- PA100-RB 100w chromed speaker roof mount 5.12kg
- PA100-G 100w Slimline speaker and cowl 5kg



Technical specification of Amplimax sirens

Voltage: 12v 11 to 16v DC or 24v 22 to 32v DC
Outputs: Standard 60w/100w 1 to 11 Ohm Loudspeaker
 High power 200w 2 to 11 Ohm Loudspeaker (7000 Series)
 Power at 12v: 5.8A - 60w, 10A - 100w, 20A - 200w
Oper Temp: -30 °C to +50 °C

- Audio**
- Frequency range: 300 to 10,000 Hz
 - Distortion (300 to 3,000) less than 5%
 - P.A. Output regulated to 60w
 - Radio input impedance: 3.2 to 2,000 Ohms
 - Microphone: Electronic microphone

Spare Part:
6000 to 7000 Conversion Loom:
Part Number 507147

Standard Frequency Range:	Cycle Rate:
Wail 500 to 1800Hz	11/min
Yelp 500 to 1800Hz	178/min
Hi-lo 670 to 1100Hz	55/min
Pulsar 500 to 1800Hz	650/min



Cooling Fan. Operating temperature range for 7000 series

- **High Power Models:** -20 °C to +35 °C
- **All other models:** -20 °C to +50 °C



Halogen Rotating Beacons



390 Series

Flexible fixing including single bolt, three bolt, magnetic and plug-in

Compact but powerful halogen rotating beacon

- UV stabilised polycarbonate lens
- Lens colour: amber, blue, E blue, clear, green, red
- Single voltage application: 12v rotator 4.5amps @ 55watts
24v rotator 3 amps @ 70watts
- Rotation speed 160/min standard



Diameter 153mm
Height 165mm
Weight: 0.77kg

390 Three bolt fixing

Popular Models
390.00 Amber
390.01 Blue
390.02 Red

391 Single bolt fixing

Popular Models
391.00 Amber
391.01 Blue
391.02 Red

Diameter 149mm
Height 206mm
Weight: 0.77kg



Diameter 149mm
Height 236mm
Weight: 0.8kg

392 Plug-in bolt fixing

Popular Models
392.00 Amber
392.01 Blue
392.02 Red

E11 Approved to regulation ECE65

e11 Approved to EMC Directive 95/54/EC for electromagnetic compatibility
Note: Red not approved

Conforms to EEC Directive 89/336/EEC CE (General), Approved to EEC 95/54 (Road Vehicles), 2000/2 (Tractors), 97/24 Chapter 8 (2-3 Wheeled Vehicles) and Approved to ECE Regulation 10 (General) for electromagnetic compatibility*



Diameter: 149mm
Height: 285mm
Weight: 1.27kg

394 Magnetic Mount



Popular Models
394.70 Amber
394.71 Blue
394.72 Red

Spare Parts for 390 series

802521 Amber lens
802534 Blue lens
802522 Red lens
550100 12v 55w H1 halogen bulb
550200 24v 70w H1 halogen bulb

Lens & Voltage Options

- Lens colours: Amber, Blue, Red
- Single voltage application: 12V or 24V
- 12V rotator: 4.5amps @ 55watts
- 24V rotator: 3amps @ 70watts

Please specify voltage when ordering



Magnetic Mount Beacons
These magnetic beacons are intended for temporary use and may detach at speeds above those indicated.



Diameter: 158mm Height: 108mm Weight: 0.4kg

880 Three bolt fixing (available in 12V or 24V)

Popular Models

880-H-12-A 12v Amber
880-H-12-B 12v Blue
880-H-12-EB 12v E Blue
880-H-12-R 12v Red
880-H-12-G 12v Green



Diameter: 158mm Height: 132mm Weight: 0.8kg

880M Magnetic Mounts (available in 12V or 24V)

Popular Models

880M-H-12-A 12v Amber
880M-H-12-B 12v Blue
880M-H-12-EB 12v E Blue
880M-H-12-R 12v Red
880M-H-12-G 12v Green

Spare Parts for 880 series

301902 Amber lens
301901 Blue lens
301901-E E blue lens
301900 Clear lens
301905 Green lens
301903 Red lens
103800 Lens clip
900910 12v rotator assembly
901001 24v rotator assembly
550100 12v 55w H1 bulb
550200 24v 70w H1 bulb



Diameter: 123mm
Height: 179mm Weight: 1.8kg

B21 Single Bolt Fixing

Popular Models

B21.00.12V
B21.00.24V

Spare Parts

10514.00 Amber Lens, Polycarbonate
H448 12V (55w) Halogen Bulb
H466 24V (70w) Halogen Bulb
27031 Bulb retaining clip



Diameter: 183mm
Height: 162mm Weight: 1.27kg

B24.70 Magnetic Mount



Popular Models

B24.70.12V
B24.70.24V

Spare Parts

10514.00 Amber Lens, Polycarbonate
H448 12V (55w) Halogen Bulb
H466 24V (70w) Halogen Bulb
27031 Bulb retaining clip



Diameter: 450mm Height: 165mm Weight: 0.4kg

668 Series Rotator Beacons

Popular Models

668-H-*-* Amber, blue, green, red
668-BM-*-* Amber, blue, green, red
668-M-*-* Amber, blue, green, red

*Specify 12v or 24v ** Specify Colour

Spares

8800102.00 Amber lens
8800101.00 Blue lens
8800103.00 Red lens
8800104.00 Green lens

Not Approved to Regulation ECE65

e11 Approved to EMC directive 95/54/EC





Low profile dimensions: Height 127mm Diameter: 147mm
 High profile dimensions: Height 178mm Diameter: 147mm

- High intensity beacon
- Ideal for airports and internal use
- UV stabilised polycarbonate lens
- All beacons feature RFI suppression
- Lens colour: amber, blue, clear, green, red
- Voltage: 12v or 24v
- Current draw: 12v 4.5amp
24v 3amp

e11 Approved to EMC Directive 95/54/EC



1024/1084 Low Profile



1024/1084 Low Profile



1026/1086 High Profile

Flashing Beacon

12Volt

- | | |
|---------------|--------------------|
| 1024-H-12-A | Three bolt fixing |
| 1024BM-H-12-A | Single bolt fixing |
| 1024M-H-12-A | Magnetic mount |
| 1026-H-12-A | Three bolt fixing |
| 1026BM-H-12-A | Single bolt fixing |
| 1026M-12-H-A | Magnetic mount |

24Volt

- | | |
|---------------|--------------------|
| 1024-H-24-A | Three bolt fixing |
| 1024BM-H-24-A | Single bolt fixing |
| 1024M-H-24-A | Magnetic mount |
| 1026-H-24-A | Three bolt fixing |
| 1026BM-H-24-A | Single bolt fixing |
| 1026M-24-H-A | Magnetic mount |

Rotating Beacon

12Volt

- | | |
|---------------|--------------------|
| 1084-H-12-A | Three bolt fixing |
| 1084BM-H-12-A | Single bolt fixing |
| 1084M-H-12-A | Magnetic mount |
| 1086-H-12-A | Three bolt fixing |
| 1086BM-H-12-A | Single bolt fixing |
| 1086M-H-12-A | Magnetic mount |

24Volt

- | | |
|---------------|--------------------|
| 1084-H-24-A | Three bolt fixing |
| 1084BM-H-24-A | Single bolt fixing |
| 1084M-H-24-A | Magnetic mount |
| 1086-H-24-A | Three bolt fixing |
| 1086BM-H-24-A | Single bolt fixing |
| 1086M-H-24-A | Magnetic mount |

Strobe Beacons

For dual voltage applications 12v & 24v



Diameter: 153mm Height: 179mm Weight: 0.77kg

290 Three bolt fixing

Popular Models

- | | |
|--------|-------|
| 290.00 | Amber |
| 290.01 | Blue |
| 290.02 | Red |

Less than 1amp current draw

e11 Conforms to EMC Directive 95/54/EC for electromagnetic compatibility



Diameter: 155mm Height: 182mm Weight: 1.27kg

294 Magnetic Mount

Popular Models

- | | |
|--------|-------|
| 294.00 | Amber |
| 294.02 | Red |

Less than 1amp current draw

e11 Conforms to EMC Directive 95/54/EC for electromagnetic compatibility



Multi Voltage Strobe Beacon

470 Two bolt fixing

Diameter: 76mm Height: 127mm Weight: 0.28kg

- Compact and powerful single flash strobe
- 60 to 80 flashes per minute
- Suitable for battery powered vehicles
- Voltage range 12-80V DC, 470AC operates at 120V AC
- Lens colours: Amber, blue, clear, green, red
- Low consumption 0.1 - 0.4 amps

Popular Models

- | | |
|--------|-------|
| 470S-A | Amber |
| 470S-B | Blue |
| 470S-C | Clear |
| 470S-G | Green |
| 470S-R | Red |

Spare part

- | | |
|--------|------------------|
| 801808 | Amber lens |
| 801806 | Blue lens |
| 801809 | Clear lens |
| 801805 | Green lens |
| 801807 | Red lens |
| 559810 | 5001 strobe tube |

Does not conform to EMC Directive 95/54/EC for electromagnetic compatibility





Low Profile: Height: 127mm Diameter: 147mm Weight: 0.5kg
High Profile: Height: 178mm Diameter: 147mm Weight: 0.6kg

- 160 flash per minute high intensity double flash strobe beacon
- UV stabilised polycarbonate fresnel lens
- Lens colours: amber, blue, clear, green, red
- Single voltage application: 12v strobe head – 1.6amps
24v strobe head – 0.8amps
- All beacons polarity protected and have RFI suppression
- Available in 12 or 24 volt

1204 and 1206 models are not approved to EMC Directive 95/54/EC

Low Profile Strobe Beacons

1204 Three bolt fixing

Popular Models
 1204-S-12-A 12v Amber
 1204-S-12-B 12v Blue
 1204-S-12-R 12v Red
 1204-S-24-A 24v Amber



1204BM Single bolt fixing

Popular Models
 1204BM-S-12-A 12v Amber
 1204BM-S-12-B 12v Blue
 1204BM-S-12-R 12v Red
 1204BM-S-24-A 24v Amber



1204M Magnetic Mount

Popular Models
 1204M-S-12-A 12v Amber
 1204M-S-12-B 12v Blue
 1204M-S-12-R 12v Red
 1204M-S-24-A 24v Amber



Spare Parts

610000 12v circuit board
 610100 24v circuit board
 551101 9041 strobe tube

Low profile

800302 Amber lens
 800301 Blue lens
 800300 Clear lens
 800304 Green lens
 800303 Red lens

High Profile Strobe Beacons



1206 Three bolt fixing

Popular Models
 1206-S-12-A 12v Amber
 1206-S-12-B 12v Blue
 1206-S-12-R 12v Red
 1206-S-24-A 24v Amber

Not Approved to Regulation ECE65



1206BM Single bolt fixing

Popular Models
 1206BM-S-12-A 12v Amber
 1206BM-S-12-B 12v Blue
 1206BM-S-12-R 12v Red

Not Approved to Regulation ECE65



1206M Magnetic mount

Popular Models
 1206M-S-12-A 12v Amber
 1206M-S-12-B 12v Blue
 1206M-S-12-R 12v Red

Weight 1.0kg

Not Approved to Regulation ECE65

High profile

800202 Amber lens
 800201 Blue lens
 800200 Clear lens
 800204 Green lens
 800203 Red lens

- Strobe power supplies carry a two year warranty and feature polarity protection, continuous duty circuitry, RFI filters to protect against radio interference and are vibration resistant.
- All units are potted for improved durability

Diagnostic Capability
 For diagnostic capability add PHOCP01
 Diagnostic Panel if required.

	PHS240-P	PHW460-P	PHW475-ND	PHW475-P	PHW675-P	PHW690-P	PHW475E
Outputs	2	2-4	2-4	2-4	2-6	2-6	4
Power (watts)	40	60	75	75	75	90	75
Ave. Amp Draw	4	6	7.3	7.3	7.3	8.8	7.3
High/Low Intensity	Yes	Yes	Yes	Yes	Yes	Yes	Yes
Flash Patterns	1	4	4	4	4	4	2
Primary Patterns	Four flash	Double flash Four flash Five flash Warp flash	Double flash Four flash Five flash Warp flash	Double flash Four flash Five flash Warp flash	Double flash Four flash Five flash Warp flash	Double flash Four flash Five flash Warp flash	Single flash Double flash
Flash rate cycles/min double flash	N/A	235	235	235	235	235	235 single 130 double
Flash rate cycles/min response flash	N/A	N/A	N/A	N/A	N/A	N/A	N/A
Flash rate cycles/min Four flash	140	140	140	140	140	140	N/A
Flash rate cycles/min Five flash	N/A	140	140	140	140	140	N/A
Flash rate cycles/min Warp flash	N/A	700	700	700	700	700	N/A
Selectable switching	Yes	Yes	Yes	Yes	Yes	Yes	Yes
Height (mm)	50	65	65	65	65	65	60
Width (mm)	170	200	200	200	200	200	200
Depth (mm)	102	125	125	125	125	125	125
Weight (kg)	0.72	2.25	2.25	2.25	2.25	2.25	2.1
Diagnostic Capability	N/A	N/A	N/A	Yes	Yes	Yes	Yes
EMC95/54 Regulation	e11	e11	e11	e11	e11	e11	e11

Flash Patterns

Double Flash

The standard double flash pattern used by emergency services throughout the world.

Four Flash

An attention catching powerful 4 flash pattern that is more distinctive than the standard double flash.

Five Flash

The Five Flash can flash so rapidly that the lamp appears to burn continuously in a pattern of 5 powerful flashes which is highly distinctive.

Warp Flash

Super Flash has an outstanding flash rate of 700 flashes per minute to produce the ultimate warning pattern.





- Please Note: Directional Lighting in general does not require EMC approval however, strobe lighting when used in conjunction with Premier Hazard strobe power supply units will conform to 95/54/EC for electromagnetic compatibility.
- Coloured lens versions are for alternating flash only.

R43 H



- Extended lens design
- Colours: Amber, blue, green, red & clear
- Voltage: 12v or 24v
- Halogen only
- Current draw 12v 2.25amp
24v 1amp

Mounting Options

- R43-BMF Bumper mount housing polished
- R43-BMF/G Bumper mount housing matt finish
- R43-DSMF Deep surface mount polished
- R43-FMF Recess mount polished
- R43-SMF Surface mount polished
- R43-TSMF 15° surface mount polished

Popular Models

- R43-H-12-A halogen, 12v, amber
- R43-H-12-B halogen, 12v, blue
- R43-H-12-R halogen, 12v, red

Spare Parts

- 308352 amber lens
- 308351 blue lens
- 308350 clear lens
- 308354 green lens
- 308353 red lens
- 550905 12v 35watt bulb (for coloured lamp)
- 550907 12v 20watt bulb (for clear lamp)
- 550906 24v 20watt bulb (for coloured lamp)

Dimensions

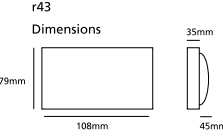

79mm, 108mm, 35mm, 45mm

R44 H



- Extended lens designed for nearer 180° visibility
- Colours: Amber, blue, clear, green & red
- Voltage: halogen in 12v/24v
- Current draw 12v 4amp
24v 2amp

Mounting Options

- PEHC84 Moulded bumper mount chrome finish
- PEMBC84 Moulded bumper mount black finish

Popular Models

- R44-H-12-A halogen, 12v, amber
- R44-H-12-B halogen, 12v, blue
- R44-H-12-R halogen, 12v, red

Spare Parts

- 820973 R44 amber lens
- 820972 R44 blue lens
- 821014 R44 clear lens
- 821042 R44 green lens
- 821013 R44 red lens
- 820994 12v 50watt halogen bulb twist lock
- 820155 24v 70watt halogen bulb

Dimensions

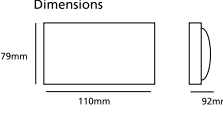

79mm, 110mm, 92mm

R431 S



- Moulded housing
- Colours: Amber, blue, green, red & clear
- Voltage: 12v or 24v
- Universal mount

Popular Models

- R431-S-A strobe, amber
- R431-S-B strobe, blue
- R431-S-R strobe, red
- R431-H-24-A Amber

Spare Parts

- 820919 R431 amber lens
- 820923 R431 blue lens
- 820918 R431 clear lens
- 820920 R431 green lens
- 820921 R431 red lens
- 820916 strobe tube – ETRTXCP

Dimensions

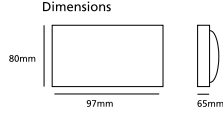

80mm, 97mm, 65mm

R432 SS HS HH



- Moulded housing
- Colours: Amber, blue, green, red & clear
- Mixed colour lenses available
- Voltage: 12v or 24
- Universal mount
- Halogen/strobe options available
- Current draw 12v 8amp
24v 6amp

Popular Models

- R432-HH-AA- double halogen, double halogen, amber/red
- R432-HH-AR- double halogen, double halogen, blue/red
- R432-HH-BR- double halogen, double halogen, blue/red
- R432-SS-AA double strobe, amber/amber
- R432-SS-AR double strobe, amber/red
- R432-HS-RB halogen-red strobe-blue

Spare Parts

- 820919 R432 amber lens
- 820923 R432 blue lens
- 820918 R432 clear lens
- 820920 R432 green lens
- 820921 R432 red lens
- 550800 12v 55watt halogen bulb
- 550900 24v 70watt halogen bulb
- 820916 strobe tube – ETRTXCP

Dimensions

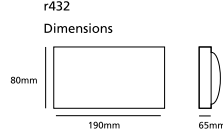

80mm, 190mm, 65mm

* Specify 12v or 24v

P36 H S



- Black rubber housing
- Colours: Amber, blue, green, red & clear
- Voltage: 12v or 24v
- Universal mount
- Complete with 2.5m strobe cable
- Current draw 12v 4amp
24v 2amp

Popular Models

- P36-H-A- halogen, amber
- P36-H-B- halogen, blue
- P36-H-G- halogen, green
- P36-S-A strobe, amber
- P36-S-B strobe, blue
- P36-S-G strobe, green

Spare Parts

- 559701 amber filter
- 559700 blue filter
- 559703 green filter
- 559702 red filter
- 554106 H7604 12v 50watt halogen sealed beam
- No 24v halogen available
- strobe sealed beam
- 553400 Rubber housing
- 555400

Dimensions

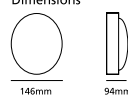

146mm, 94mm

* Specify 12v or 24v

R37 S SS HS HH



- Wide or narrow beam options
- Colours: Amber, blue, red & clear
- Split colour lens for two colour options
- Voltage: 12v or 24v halogen lamps or strobe heads
- Halogen/strobe options available
- Sealed unit replacement lens and strobe options not available
- Current draw 12v 4.5amp
24v 2amp

Popular Models

- R37-HH- double halogen, amber, wide beam
- R37-HH- double halogen, clear/blue, wide beam
- R37-SS- linear strobe, amber, wide beam
- R37-HS- halogen-red/strobe-blue, wide beam

Spare Parts

- No spare lenses available
- 807910 12v 50watt 890 halogen bulb
- 807910-24 24v 70watt 890 halogen bulb

R37 Mounting Options

- R37-BMF Bumper mount housing – polished
- R37-BMF/G Bumper mount housing – matt finish
- R37-DSMF Deep surface mount – polished
- R37-FM 15° down bumper mount – polished
- R37-FMF Recess Mount Polished
- R37-SMF Surface mount – polished
- R37-TSMF 15° down surface mount – polished

Dimensions

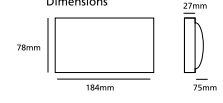

78mm, 184mm, 27mm, 75mm

* Specify 12v or 24v
** Specify Colour



R73 SS HS HH

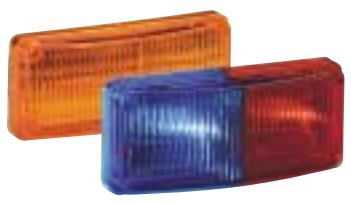

- Extended lens for approx 180° visibility
- Colours: Amber, blue, red & clear
- Mixed colour lenses available
- Voltage: 12v or 24v
- Halogen/strobe options available
- Current draw 12v 8amp
24v 4amp

Mounting Options

- PEHC 37 Moulded bumper mount – Chrome finish
- PEHB 37 Moulded bumper mount – Black finish

Dimensions

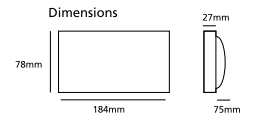

Popular Models

- R73-HH-12-AR double halogen, 12v, amber/red
- R73-HH-12-BR double halogen, 12v, blue/red
- R73-HS-RB halogen-red/strobe-blue
- R73-S-A linear strobe, amber
- R73-SS Double strobe

Spare Parts

- 821029 R73 amber lens
- 821054 R73 blue lens
- 821050 R73 clear lens
- 821041 R73 red lens
- 820994 12v 50watt halogen
- 820995 strobe tube – PF135SC
- 821000 linear strobe tube

R79 SS HS HH



- Colours: Amber, blue, clear & red
- Mixed colour lenses available
- Voltage: 12v or 24v
- Halogen/strobe options available
- Current draw 12v 4.5amp
24v 2amp

Dimensions

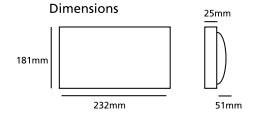

Popular Models

- R79-HH-12-AR double halogen, 12v, amber/red
- R79-HH-12-BR double halogen, 12v, blue/red
- R79-SS-BR double strobe, blue/red
- R79-S-A linear strobe, amber
- R79-HS-24-RB halogen-24v red/strobe-blue

Spare Parts

- 807910 12v 50watt 890 halogen bulb
- 807910-24 24v 70watt 890 halogen bulb

No spare lenses available

R79



Mounting options

- R79-SMF Surface mount
- 820624 26° forward fixture
- R79-FM Recess mount

R37/73/79 Colour Options

AA Amber/Amber	CB Clear/Blue
AB Amber/Blue	RB Red/Blue
AR Amber/Red	BB Blue/Blue
B Blue	CC Clear/Clear
BR Blue/Red	RR Red/Red
C Clear	

PSE40 H S

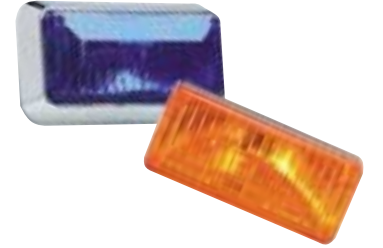

- Sculpted lens
- Colours: Amber, blue, green & red
- Voltage: 12v or 24v
- Chrome coated bezel available
- Current draw 12v 4amp
24v 2amp

Dimensions

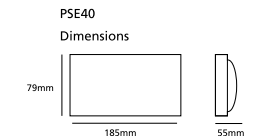

Popular Models

- 41-H-A-* halogen, amber
- 41-H-B-* halogen, blue
- 41BZ-H-B-* halogen, blue c/w bezel
- 40-S-A strobe, amber
- 40-S-B strobe, blue
- 40BZ-S-B strobe, blue c/w bezel

* Specify voltage 12v or 24v

Spare Parts

- 830028 amber lens
- 830030 blue lens
- 830280 green lens
- 830284 red lens
- 830354 chrome bezel
- 550926 12v 35watt halogen bulb
- 550912 12v or 24v 50watt halogen bulb
- 550924 Helix twist and lock strobe tube

- Please Note: Directional Lighting in general does not require EMC approval however, strobe lighting when used in conjunction with Premier Hazard strobe power supply units will conform to 95/54/EC for electromagnetic compatibility.
- Coloured lens versions are for alternating flash only.

H412 Slimline H S



- Colours: Amber, blue, clear & red
- Voltage: 12v or 24v
- Universal mount
- Current draw 12v 4.5amp
24v 3amp

Dimensions

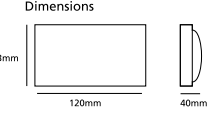

Popular Models

- H412-H-A-* halogen, amber
- H412-H-B-* halogen, blue
- H412-H-R-* halogen, red
- H412-S-A strobe, amber
- H412-S-B strobe, blue
- H412-S-R strobe, red

* Specify voltage 12v or 24v

Spare Parts

- 550800 12v 55watt halogen bulb
- 550900 24v 70watt halogen bulb
- 820916 Strobe tube ETRTXCP

No spare lenses available

R602 H S



- Colours: Amber, blue, clear & red
- Voltage: 12v or 24v
- Internal lamp housing can be for spot or flood
- Backing available in black or white
- Optional 15° angled plinth
- Current draw 12v 4.5amp
24v 3amp

Dimensions

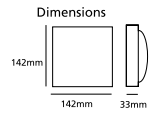

Popular Models

- R602-H-A-SP-BL-* halogen, amber, spot, black housing
- R602-H-B-SP-WH-* halogen, blue, spot, white housing
- R602-S-B-BL strobe, blue, black housing

* Specify voltage 12v or 24v

Spare Parts

- 306108A Amber lens
- 306108B Blue lens
- 306108C Clear lens
- 306108BE "E" Blue lens
- 306108R Red lens
- 306109BL Black backing
- 306109W White backing
- 550800 12v 55watt H3 halogen bulb
- 550900 24v 70watt H3 halogen bulb
- 550173 Spot lamp housing without bulb
- 550174 Flood lamp housing without bulb
- R602-15-W 15° White Plinth
- 553401 Strobe sealed beam Par36

2030 Surface Mount I



- Colours: Amber, blue, clear & red
- Voltage: 12v or 24v
- Current draw 12v 2.25amp
24v 1.25amp

Dimensions

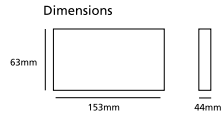

Popular Models

- 2030-I-12-A Incandescent, 12v, amber
- 2030-I-12-B Incandescent, 12v, blue
- 2030-I-12-R Incandescent, 12v, red
- 2030-I-24-A Incandescent, 24v, amber
- 2030-I-24-B Incandescent, 24v, blue
- 2030-I-24-R Incandescent, 24v, red

Spare Parts

- 559957 Amber lens
- 559959-B Blue lens
- 559953 Clear lens
- 559959-R Red lens
- 550500 12v Incandescent bulb
- 550700 24v Incandescent bulb

3020 HH



- Colours: Amber, blue, green & red
- Voltage: 12v or 24v
- Recess mount
- Current draw 12v 2.25amp
24v 1.25amp

Dimensions

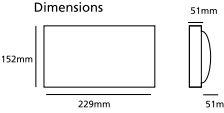

Popular Models

- 3020-H-12-A halogen, 12v, amber
- 3020-H-12-B halogen, 12v, blue
- 3020-H-12-R halogen, 12v, red
- 3020-H-24-B halogen, 24v, blue
- 3020-H-24-R halogen, 24v, red

Spare Parts

- Full lamp replacement only



6101 Surface Mount

H S

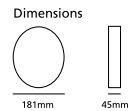
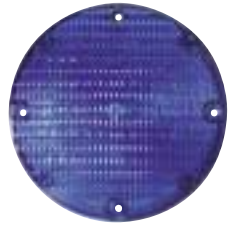

- Colours: Amber, blue, clear & red
- Voltage: 12v or 24v
- Round flat back surface mount
- Complete with 2.5m strobe cable
- Current draw 12v 4amp
24v 2amp

Popular Models

6101-H-12-A halogen, 12v, amber
6101-H-12-B halogen, 12v, blue
6101-H-24-A halogen, 24v, amber
6101-S-A strobe, amber
6101-S-B strobe, blue

Spare Parts

559948 Amber lens
559943 Blue lens
806213 Clear lens
806210 Red lens
559610 12v 50watt halogen S795 bulb
559612 24v 50watt halogen S795 bulb
558800 Strobe tube
559000 Strobe trigger

7101 Surface Mount

H S

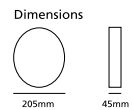

- Colours: Amber, blue, clear & red
- Voltage: 12v or 24v
- Round flat back surface mount with chrome flange
- Complete with 2.5m strobe cable
- Current draw 12v 4amp
24v 2amp

Popular Models

7101-H-12-A halogen, 12v, amber
7101-H-12-B halogen, 12v, blue
7101-H-24-A halogen, 24v, amber
7101-S-A strobe, amber
7101-S-B strobe, blue

Spare Parts

559948 Amber lens
559943 Blue lens
806213 Clear lens
806210 Red lens
559610 12v 50watt halogen S795 bulb
559612 24v 50watt halogen S795 bulb
558800 Strobe tube
559000 Strobe trigger

7201

H S

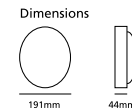

- Ideal as internal light
- Colour: Amber, blue, clear & red
- Voltage: 12v or 24v
- Recess mount with flat back and chrome flange
- Complete with 2.5m strobe cable
- Current draw 12v 4amp
24v 2amp

Popular Models

7201-H*-A halogen, amber
7201-H*-B halogen, blue
7201-H*-C halogen, clear
7201-S-A strobe, amber
7201-S-B strobe, blue

* Specify voltage 12v or 24v

Spare Parts

559948 Amber lens
806300 Blue lens
806213 Clear lens
806210 Red lens
559610 12v 50watt halogen S795 bulb
559612 24v 50watt halogen S795 bulb
558800 Strobe tube
559000 Strobe trigger
559000 24v 70watt H3 Halogen

7045 Trauma Light

H I

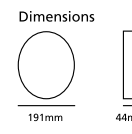

- Colour: Clear
- Voltage: 12v only
- Socket type bulb holder - dual halogen & incandescent bulbs
- Recess mount with flat back and chrome flange
- Current draw:
Halogen 12v 4.5amp
Incandescent 24v 3amp

Popular Models

7045-H-12-C halogen, 12v, clear
7045-I-12 Incandescent

Spare Parts

806213 Clear lens
559653 9018-0034 12v 37.5w bulb
559654 9018-0035 12v 9w bulb

9101 Surface Mount

H S

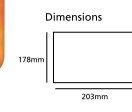
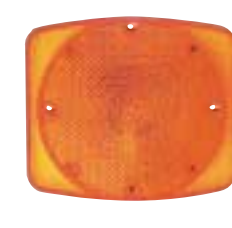

- Colours: Amber, blue, clear & red
- Voltage: 12v
- Flat back surface mount
- Complete with 2.5m strobe cable
- Current draw 12v 4amp
24v 2amp

Popular Models

9101-H-12-A halogen, 12v, amber
9101-H-12-B halogen, 12v, blue
9101-H-12-R halogen, 12v, red
9101-H-24-A halogen, 24v, amber
9101-S-A strobe, amber
9101-S-B strobe, blue

Spare Parts

559948 Amber lens
559943 Blue lens
806213 Clear lens
806210 Red lens
559610 12v 50watt halogen S795 bulb
558800 Strobe tube
559000 Strobe trigger

R602 Scene Light

H S



- Colour: Clear
- Voltage: 12v or 24v
- Internal lamp housing can be for spot or flood
- 15° angled plinth available
- Current draw 12v 4.5amp
24v 3amp

Popular Models

R602-H-12-C halogen, 12v, clear
R602-H-24-C halogen, 24v, clear
R602-15 15° plinth
R602-5 strobe head

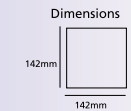

Spare Parts

306108-C Clear lens
306109W White backing
550800 12v 55watt H3 halogen bulb
550900 24v 70watt H3 halogen bulb
550173 Spot lamp housing without bulb
550174 Flood lamp housing without bulb
553401 Strobe sealed beam Par 36

3010 Scene Light

H



- Colour: Clear
- Voltage: 12v
- 13° or 26° internal tilt lenses provide a work light without the need for angled mounts
- Current draw 12v 2.25amp

Popular Models

3010-13-H-12-C halogen, 12v, clear, 13° tilt
3010-26-H-12-C halogen, 12v, clear, 26° tilt

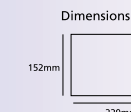

Spare Parts

559935 Clear lens
559680 Internal diffuser (13°)
559651 12v 27watt bulb

3010 Mounting options



- 3015: 15° angled surface mount
 - 3016: full recess mount
- Other mounting options available

PSE40 Scene Light

H



- Colour: Clear
- Voltage: 12v
- 26° internal tilt lenses
- Other tilt lens options available
- Chrome coated bezel available
- Current draw 12v 4amp
24v 2amp

Popular Models

41-26-H-12-C halogen, 12v, clear, 26°
41Z26-H-12-C halogen, 12v, clear, 26° c/w bezel
41-26-H-24-C halogen, 24v, clear, 26°
41Z26-H-24-C halogen, 24v, clear, 26° c/w bezel

Spare Parts

830031 Clear lens
830354 Chrome coated bezel
550925 12v 50watt halogen
550912 24v 50watt halogen

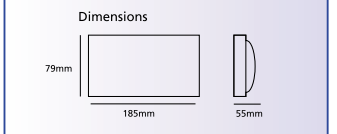

PSE80 Scene Light

H



- Colour: Clear
- Voltage: 12v
- 26° internal tilt lens
- Other tilt lens options available
- Chrome coated bezel available
- Current draw 12v 4amp
24v 2amp

Popular Models

81-26-H-12-C halogen, 12v, clear, 26°
81Z26-H-12-C halogen, 12v, clear, 26° c/w bezel
81-26-H-24-C halogen, 24v, clear, 26°
81Z26-H-24-C halogen, 24v, clear, 26° c/w bezel

Spare Parts

830303 Clear lens
830208 Chrome coated bezel
550925 12v 50watt halogen
550912 24v 50watt halogen





620 Flasher Unit



e11 Approved to automotive EMC directive 95/54/EC

The following units can be used to control directional lights, headlights, fog lights etc. or a combination. (e.g. Headlights and a pair of grille lights).

Popular Models

- 620-101**
Electronic alternating flasher 2 x 10 amps (max). Dual Voltage
- 620-102**
Electronic headlight pulsating flasher 1 x 10 amps (max). Dual voltage
- 620-103**
Electronic headlight alternating flasher unit. 12v or 24v
- 620-103K**
Electronic headlight alternating flasher kit, includes relays. 12v or 24v.
- 620-103KI**
Electronic headlight alternating flasher kit, includes relays and a side light override. 12v or 24v
- 620-105**
Electronic headlight alternating flasher and one set of auxiliary alternating outputs. 12v only
- 620-108**
Electronic alternating flasher with steady override, can be used on fog lights. 12v only
- 620-109**
Electronic headlight pulsating flasher, includes a set of auxiliary alternating outputs and a side light override. 12v only
- 562506-12v**
30A Changeover relay

Code 3 Flasher Units

UK only



e11 Approved to EMC directive 95/54/EC

Popular Models

- 700**
Solid state alternating flasher unit 2 x 8 amps (max) 12v or 24v
- 710**
Solid state alternating flasher unit 2 x 8 amps (max) 12v or 24v. Programmed with various flash patterns
- 711**
Solid state alternating flasher unit 2 x 8 amps (max) 12v or 24v

More varied flash patterns available

Solid State Flasher Units



e11 Approved to EMC directive 95/54/EC

Popular Models

- ETAFO8-12P**
Solid state alternating flasher unit 2 x 8 amps (max). 12v only
- ETAFO8-24P**
Solid state alternating flasher unit 2 x 8 amps (max). 24v only
- ETAF15-12P**
Solid state alternating flasher unit 2 x 15 amps (max). 12v only. To suit four lamps
- ETAF15-24P**
Solid state alternating flasher unit 2 x 15 amps (max). 24v. To suit four lamps

SFC100



e6 Approved to EMC directive 95/54/EC

SFC100 Features

- Dual voltage
- IP65 Rating
- Reverse Polarity Protected
- Over Load Protection
- Over Current Protection
- Thermal Cut-out
- Shock-proof

SFC200



e6 Approved to EMC directive 95/54/EC

SFC200 Features

- More than 20 included patterns
- Dual signal inputs for automation
- Dual voltage
- IP65 Rating
- Reverse Polarity Protected
- Over Load Protection
- Over Current Protection
- Thermal Cut-out
- Shock-proof



e11 Approved to automotive EMC directive 95/54/EC

Height: 48mm Width: 114mm Depth: 71mm

- 444-N** 4 x 10A relay power distribution unit. 12v negative switching. Integral fuses
- 444-P** 4 x 10A relay power distribution unit. 12v positive switching. Integral fuses





The ultimate solution for all vehicles

Standard switches do not require EMC approval

Unity Switch Panel and Control Box

- Vehicle specific face plates available
- 6 Backlit push switches with variable legends
- Variable flash patterns via integral flasher unit

- 6 Relays with minimum 25 amps rating
- Alternating/Pulsing circuit with two outputs for headlights

Approved to automotive EMC directive 95/54/EC



Height: 41mm Width: 123mm Depth: 39mm

316 6 Function switch panel



Approved to automotive EMC directive 95/54/EC

Height: 50mm Width: 77mm Depth: 25mm

688-N 8 Function 12v switch panel
12v negative switching. Integral fuses

688-P 8 Function 12v switch panel
12v positive switching. Integral fuses

- Compact & lightweight
- Easy to locate recessed switches
- Back lit for night time use
- LED's indicate which function is selected
- Suitable for low current switching



Height: 51mm Width: 51mm Depth: 44mm

302 1 Function switch panel
303 Function switch panel



Height: 51mm Width: 118mm Depth: 44mm

306 3 Function switch panel

- High power switching, no extra fuses and relays required for outputs.
- All output fuses on back unit for easy maintenance. LED status indicator for fault finding on each output.
- Small size for backboard installation.
- Plug and play system for ease of use.
- Unit integrates with 8000 siren system.
- Lockable programming at installation stage stops programming being changed in vehicle.
- Built-in arrowbar controller on larger version saving time on installation. No extra controller to fit.
- Selectable audible warning to indicate output(s) enabled.
- Non damaging mounting bracket for easy installation.
- Built in microphone.
- Large positive action keys.
- Back lit.
- Automatic light sensor.
- Universal mounting bracket.
- Polarity protection with LED indicators.
- Fused output.

The kit comprises of:

- Handset
- Rear control box
- Control box connectors
- Curly cord
- 6 way extension cord
- 6 way handset interface
- Detailed instruction leaflet

Multitouch Controller



Approved to 2004/104/ec (supercedes 95/54 eec) 89/336/ec (CE marked) PITO AES specification 5 issue 9

Speedtouch Controller



Approved to 2004/104/ec (supercedes 95/54 eec) 89/336/ec (CE marked) PITO AES specification 5 issue 9



Auxiliary Units

The ultimate solution for all vehicles

Covert Info Sign



Height: 4"
Width: 20"
Depth: 2.5"

Product Specifications

Available colours	A-Amber, R-Red
CPL (Characters/Line)	8
LED rating	100,000 hrs
External mount	Yes
Programmable messages	80
Text messaging	Yes
Symbols	Yes
Fixed message	Yes
Scrolling message	Yes
Arrow message	Yes

The Info Sign is a rear deck message sign providing roadway communication to approaching traffic. It is a complete warning package including arrow warnings (left, right, centre out and flash), flashing text and scrolling text displayed using a high-intensity LED array. The sign is highly visible in bright sunlight and incorporates a dimmer function for night-time use.

It is low current draw and rugged solid state LED display stands up to road shock and vibration and does not have a lamp tyre filament to break. One of the LEDs features a long life performance rating of over 100,000 hours. Solid state LED design ensures durability against road shock and vibration providing low maintenance and extended life span. Can store up to 80 programmed messages, incorporating both text and symbol. Messages can be displayed fixed, flashing or scrolling. Quick message selection by scrolling push buttons. Motorised activation allows unit to stay concealed until the sign is activated. For pop up or drop down positioning.

Controller and 18" cable included. CD Rom for programming.

Hide Away LEDs



Features

- 70 flashes per minute minimum. Fast rate is 100 flashes per minute.
- 12v DC, 1 amp maximum.
- '3' LED module to provide spectacular warning signal.
- Virtually maintenance free - rugged and reliable LED performance.
- Nearly impossible to detect in side markers or tail lights until activated.
- Flasher is potted for weather protection and suitable for trunk or under-hood mounting.
- Up to 15 user-selectable flash patterns.
- Designed to be installed in rear light clusters without need to cut into existing wiring.
- No need to remove existing bulbs ideal for covert and overt.

Auxiliary Units

The ultimate solution for all vehicles

Roof Mount Kits

- One of the strongest lightbar roof mounting kits available.
- Fully adjustable so the plane of the lightbar can be changed through all critical angles.
- Universal fit.
- Secure allen key locking nuts.
- Allows for various roof contours.



Quick Release Connectors

Allows you to separate a vehicle's lightbar from its cable with a quarter turn of the connector.

- A gasket provides a seal between the housing and the vehicle roof.
- Connector assembly includes a rubber boot, which provides a watertight seal over the connectors once attached, and a plastic loom, which protects the wires entering a lightbar.
- Connector housing is permanently mounted to the rooftop of the vehicle with four screws and protects the female end of the 23 pin connector.





- Lightweight & compact warning systems
- Strobe or halogen directional lights
- Siren Amplifier with or without PA
- Two mast options with strobe or halogen beacons
- Full details on directional lighting heads, sirens & beacons can be found in the relevant sections



6002 Remote Mount Siren

Width: 140mm
Height: 30mm
Depth: 65mm
Weight: 0.5kg

- Compact 4 tone siren
- To be used with 35 watt loudspeaker
- Suitable for motorcycles

Standard tones: Wail, Yelp, Hi Lo, Air Horn
Requires separate switch panel

Motorcycle Kits



PMC Extending motorcycle mast

LXEXBIF-B Sealed LED light heads

490 Strobe beacon; or
1204 Strobe beacon; or
880 Halogen beacon

R43; or
R431; or
R432 Rear lights
(Halogen or strobe)

SIRENS
6002; or
7004 Remote mount; or
7006 Remote mount

PA35-R
35watt speaker
PA60-R
60watt speaker; or
PA100-R
High power light weight compact 100w speaker just 3.4kg

e11 Approved to EMC
directive 95/54/EC

e11 Approved to
directive 97/24/EC

PMC1-H-12-* REAR MAST KIT
consisting of:
1 x PMC stainless steel extending mast
1 x Mast bracket
1 x 880 halogen beacon

PMC5-S-12-* REAR MAST KIT
consisting of:
1 x PMC stainless steel extending mast
1 x Mast bracket
1 x 490 strobe beacon
1 x PHS240-P 40w power supply

PMC4-S-12-* MAST & FRONT LIGHT KIT
Kit consisting of:
2 x P36 sealed beam strobe heads
1 x PMC stainless steel extending mast
1 x Mast bracket
1 x 490 strobe head
1 x PHW475-P 75w power supply

Spare Parts

PMS 340-P
Motorbike Powerpack 3 output 40watt
PMC
Stainless steel Extending Mast
MCBKT
PMC Mast mounting bracket



(*)(**) Colour Option Guide
Please add suffix of your
required colour to the code
number as follows:
A = Amber
B = Blue
R = Red
G = Green
CB= Covert Blue
(only available for 2RG Kit)
CR= Covert Red
(only available for 2RG Kit)

Super Bright LED Temporary Marking Units

Electro-Flare is a heavy duty LED flashing device for temporary marking applications. Its versatility makes Electro-Flare the ideal choice for a range of applications including:

- Directional Markers
- Construction
- Road Hazards
- Accident Scenes
- Landing Strips
- Traffic Control
- Transportation
- Helipads

Electro-Flare



Height: 51mm (2")
Diameter: 152mm (6")
Weight: 485grams (1lb)



Top



Bottom

Features

- Highly Visible - 360 degree coverage from 48 super bright LED's
- Wide range of flash patterns
- Over 10 hours of continuous use
- Rechargeable battery pack giving complete charge in four hours
- Complete with charge box
- More than 10 different colours and combinations
- Weather resistant to IP67
- CE approved

Part Numbers

Electro-Flare-6-A 6 Amber modules in charge case
Electro-Flare-6-B 6 Blue modules in charge case
Electro-Flare-6-R 6 Red modules in charge case
E-Flare-A Single Electro-Flare Amber
E-Flare-B Single Electro-Flare Blue
E-Flare-R Single Electro-Flare Red
E-Flare-Adaptor Cigar Lighter Connector
E-Flare-Charger Charger box for Electro-Flare





High intensity InfoSigns using minimal power- 1A at 12V

e11 Approved to automotive
EMC Directive 95/54/EC



Standard Messages

POLICE **POLICE/STOP**

Height: 80mm Width: 240mm Depth: 40mm (stand alone unit)

45mm CD Fixed Message Infosign

- 45mm high characters
- Designed for Police use only
- Red or amber LED's for front or rear signs
- Steady and flashing Police messages
- Alternating Police/Stop messages
- Mirror image characters available
- Rocker switch controls
- Impact resistant ABS case (stand alone unit)

Part Numbers

CD Stand alone unit
CM Lightbar mounted unit
(for Lomax & Midimax lightbars only)

60mm PD Fixed Message Infosign

Height: 96mm Width: 404mm Depth: 26mm (stand alone unit)

Standard Messages & Also in Mirror Image

POLICE/STOP **POLICE/STOP/SLOW**

- 60mm high characters
- Two or three fixed messages
- Red or amber LED's for front or rear signs
- Steady or flashing messages
- Mirror image characters available
- High/low intensity control
- Rocker switch controls
- Impact resistant ABS case (stand alone unit)

Part Numbers

PD2-60 Stand alone units with 2 messages
PD3-60 Stand alone units with 3 messages
MD2-60 Lightbar mounted unit with 2 messages
MD3-60 Lightbar mounted unit with 3 messages



Height: 96mm Width: 404mm Depth: 26mm (stand alone unit)

75mm Programmable Infosign

- 75mm high characters
- 6-10 character display
- Three or ten pre-programmed messages
- Red or amber LED's for front or rear signs
- Steady, flashing or scrolling messages
- Any message in most languages
- Alphanumeric or mirror image characters
- High/low intensity control
- Rotary & rocker switch controls
- Impact resistant ABS case (stand alone unit)

Part Numbers

PD3-75 Stand alone units with 3 messages
PD10-75 Stand alone units with 10 messages



Standard Messages

FOLLOW ME **SLOW** **STOP**

Height: 96mm Width: 404mm Depth: 26mm (stand alone unit)

Fibre Optic Sign

- 83mm high characters
- Fixed three message display
- Amber, green and red fibre optics
- Steady or flashing messages
- For lightbar mounting only
- Power consumption: 4.5A at 12v

Part Numbers

M03L Three message infosign
265 Control Unit



Please Note: The PM versions are not waterproof

Height: 122mm Width: 598mm Depth: 58mm (stand alone unit) Power Consumption: 3A at 12V

90mm PM User Programmable Infosigns

- 90mm high characters
- 8-12 character display
- 8 characters allow double row LED's
- Red or amber LED's for front or rear signs
- Steady, flashing or scrolling messages
- Alphanumeric & mirror image characters available
- Impact resistant ABS case (stand alone unit)
- Control unit included

Part Numbers

PM10-90 Stand alone unit with 10 messages MM10 - 90 lightbar mount 10 message
PM30-90 Stand alone unit with 30 messages MM30 - 90 lightbar mount 30 message
PM99-90 Stand alone unit with 99 messages MM99 - 90 lightbar mount 99 message



Height: 162mm Width: 572mm Depth: 75mm (stand alone unit)

75mm PF Flip-up Infosigns

- All the features of the 75mm PD Infosigns
- Designed for covert Police vehicles
- Sits discreetly on parcel shelf until required
- Can be fitted with directional halogen or strobe lights
- Control unit included

Part Numbers

PD3F-75 Three message flip-up Infosign with 75mm high characters
PD10F-75 Ten message flip-up Infosign with 75mm high characters

e11 Approved to automotive
EMC Directive 95/54/EC



Height: 162mm Width: 572mm Depth: 60mm (stand alone unit)

Control Units and Programmers

- Software available to re-programme own messages
- Rotary switches for easy message selection
- High/low intensity control
- 30 & 99 message handsets have message preview facility to verify message before it is displayed
- 99 message handset can link up to 10 messages

Part Numbers

ICP-3 3 Message control unit for MD3-75 & PD3F-75
ICP-3F 3 message control unit for PD3F-60
ICP-10 10 message control unit for MD10-75, PD10-75 & PD10F-75
ICP-10-90 10 message control unit for MM10-90 & PM10-90
ICP-30-90 30 Message control unit for MM30-90 & PM30-90
ICP-99-90 99 Message control unit for MM99-90 & PM99-90

e11 Approved to automotive
EMC Directive 95/54/EC





The quick extending, roof mounted flood lighting system

Height: 1640mm (64.5") up to 4572mm (180")

- Nightscan sits horizontally on the vehicle roof until needed. A single button operation is all that is required to fully elevate one of the three mast options to its vertical position.
- The light heads can be positioned either 2m, 3.3m or 4.5m above the vehicle. No passenger or storage space is sacrificed.



For NS6 only
Complies with Low voltage directive 73/23/EEC, EMC directive 89/336/EEC & Machinery Directive 98/37/EC.
e11 Approved to EMC directive 95/54/EC



Nightscan NS6 – 2m Mast

- Suits all applications from small cars to fire trucks
- Up to 3600w of lighting power available
- 500/750/900/1000 or 1500w AC incandescent halogen heads (110v or 240v)
- 70,150w DC metal halide heads (12v or 24v only) – not EU approved
- Self contained air supply to raise mast
- One button "Auto Stow"
- Stowed height of 203mm
- Raises to vertical in 15 seconds
- 330° pan and tilt light heads
- Can be used for radio antennae, CCTV etc



Nightscan NS10 (3.3m) & NS15 (4.5m) Masts

- Suited to the larger fire & utility vehicles
- Up to 9000w of lighting power available
- 500/750/900/1000 or 1500w AC incandescent halogen heads
- Operates from vehicles air supply or self contained air extension system
- One button "Auto Stow"
- Stowed height of 279mm
- Raises to vertical in approximately 60 seconds
- 385° pan and 330° tilt light heads
- Internally wired
- Dual Tilt Heads. Left and Right tilt heads work independently of each other

- Each Nightscan can be operated with one of 3 controllers- Standard HC1, HR1 and Heavy Duty HC2 Remote Control
- Tested whilst elevated to wind speeds of up to 65mph
- High strength ball screw actuator provides long reliable life
- High strength heat treated aluminium alloy tubes and collars
- Low friction synthetic bearings for smooth operation and long life
- Bumpers to reduce shock on extension and retraction
- All exterior mast surfaces are anodised and sealed



Optional Half Bars



- Enhance the Nightscan with an Optimax half bar built to your specification

Dimensions

All measurements are in mm

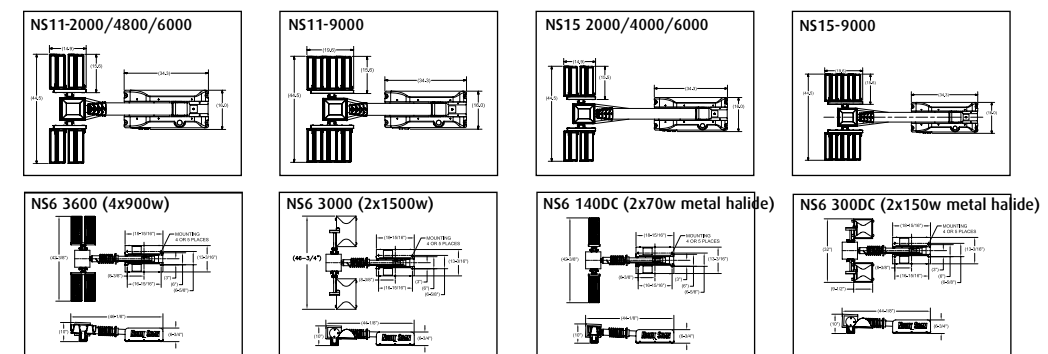

Technical Specifications

Model	Extended Height	Light Heads	Controller Electrics	Pan Degrees	Tilt Degrees	Weight	Air Supply
NS6	1640mm	No light heads or pan/tilt controller	12V or 24V	NA	NA	26KG	Self contained
NS6 RCP-1000*	2040mm	2 X 500W 110V or 240V halogen	12V or 24V	330	330	36KG	Self contained
NS6-RCP-2000**	2040mm	4 X 500W 110V or 240V halogen	12V or 24V	330	330	39KG	Self contained
NS6-140-DC	1990mm	2 X 70W 12V or 24V metal halide	12V or 24V	330	330	45KG	Self contained
NS6-300-DC	1990mm	2 X 150W 12V or 24V metal halide	12V or 24V	330	330	45KG	Self contained
NS10-2000	3352mm	4 X 500W 110V or 240V halogen	12V or 24V	385	330	65KG	Requires 20PSI – or self contained
NS10-4000	3352mm	4 X 1000W 110V or 240V halogen	12V or 24V	385	330	65KG	Requires 20PSI – or self contained
NS10-6000	3352mm	4 X 1500W 110V or 240V halogen	12V or 24V	385	330	65KG	Requires 20PSI – or self contained
NS10-9000	3352mm	6 X 1500W 110V or 240V halogen	12V or 24V	385	330	69KG	Requires 20PSI – or self contained
NS15-2000	4572mm	4 X 500W 110V or 240V halogen	12V or 24V	385	330	82KG	Requires 20PSI – or self contained
NS15-4000	4572mm	4 X 100W 110V or 240V halogen	12V or 24V	385	330	82KG	Requires 20PSI – or self contained
NS15-6000	4572mm	4 X 1500W 110V or 240V halogen	12V or 24V	385	330	82KG	Requires 20PSI – or self contained
NS15-9000	4572mm	6 X 1500W 110V or 240V halogen	12V or 24V	385	330	86KG	Requires 20PSI – or self contained

For spot and flood light options please enquire. *NS6-RCP-1000 Option of 2 X 1000W heads **Option of 4 X 1000W heads

For further details or technical specifications on any nightscan product please contact our sales department

Tel: +44 (0)113 239 1111





Scanlite range of Spotlights and Floodlights

The Scanlite Range of search lights offer outstanding lighting performance. Each unit is fitted with a sealed beam halogen bulb, a damage free clutch mechanism and long life gear assembly. The control panel is supplied with 4.5m of cable.



1355L Spot/Floodlight

1355L-12 12v
1355L-24 24v
Approved to CE directive 89/336

- 100,000 Candlepower
- High impact polycarbonate case
- "Bulb only" vertical tilt

Specifications

Horizontal sweep	360°
Vertical sweep	75°
Voltage	12v & 24v
Wattage Spot	100w
Wattage Flood	50w
Amp draw	8amp



380SL Spot/Floodlight

- Spotlight: 30,000 Candlepower
- Floodlight: 72,000 Candlepower
- Tough chrome finish brass case

Specifications

Horizontal sweep	370°
Vertical sweep	60°
Voltage	12v only
Wattage Spot	100w
Wattage Flood	50w
Amp draw	8amp



W: 178mm H: 230mm Depth: 85mm

L18 Duo Spot Beam

L18.00.LB Flood
L18.100.LB Spot

- Impact & heat resistant polypropylene housing
- Polycarbonate lens
- Bulb not included

Spare Parts

118550.00	Lens assembly, flood
118550.01	Lens assembly, Spot
H453	12V bulb x2
H460	24V bulb x2



Remote Control Spotlight

Part No. 05.0885

- Radio remote control worklamp offering complete horizontal and vertical rotation
- Incline up and down at approximately 260 degrees.
- Joy stick control enabling simultaneous horizontal and vertical movement
- Automatic resetting
- Remote control working on European Frequency 433.02mhz
- Functional up to 100m in open space
- Special clip on support for installation in vehicle



W: 178mm H: 230mm Depth: 85mm

2994F Floodlight

2994F 12v
2994F 24v

- Impact & heat resistant polypropylene housing
- Polycarbonate lens

2994FM Floodlight

2994FM-12 12v
2994FM-24 24v

Magnetic mount version of 2994F with coil lead & plug

Spare Parts

550800	H3 12v Bulb
550900	H3 24v bulb



W: 178mm H: 230mm Depth: 85mm

L17

L17.00.LB Flood
L17.100.LB Spot

- Impact & heat resistant polypropylene housing
- Polycarbonate lens
- Bulb not included

Spare Parts

118549.00	Lens assembly, flood
118549.01	Lens assembly, Spot
H453	12V bulb x2
H460	24V bulb x2



W: 168mm H: 255mm Depth: 115mm

2990F Floodlight / 2990S Spotlight

- Impact & heat resistant polypropylene housing
- Polycarbonate lens

2990FM Floodlight / 2990SM Spotlight

Magnetic mount version of 2990F with coil lead & plug

Part Numbers

2990FM-12	12V	550800	H3 12v Bulb
2990FM-24	24V	550900	H3 24v bulb
2990SM-12	12V		
2990SM-24	24V		



Double Vision Rechargeable Search Light

DV1 UK Adaptor
DV2 European Adaptor

- 2,000,000 Candle light power
- Super quartz halogen spotlight
- Swivel searchlight
- Two position handle
- Complete with 6v 4ah sealed lead acid battery and charger

 **Magnetic Mount Beacons**
These magnetic beacons are intended for temporary use and may detach at speeds above those indicated.





Quality by Design

Optional bespoke lettering and logo's available for all Premier Hazard lightbar illuminated centre sections.

Contact our sales department on:

Tel +44 (0)113 239 1111

Fax +44 (0)113 239 1131

www.premierhazard.co.uk