

Kylmäaineletkujen ja -liittimien valintaopas

- Ilmastointijärjestelmän pääkomponenttien valinnan jälkeen suunnitellaan järjestelmän letkuttaminen.
- Liittimiksi voidaan valita joko
 - a) puristettavat liittimet
 - b) kierrettävät liittimet tai
 - c) jousikiristeiset liittimet
- Liitin- ja letkuvalinnat voidaan tehdä käyttäen apuna oheista liitântäkaaviota.
- Pääkomponenteissa on lähes poikkeuksetta kuvan mukaiset liitännät, mutta sopivuus on varmistettava aina asennuskohtaisesti.

Kuvan merkinnät:

- Letku -numero = letkun nimelliskoko esim. Letku -12
- Numero" = liittimen kierre (tuumakoko) esim. 5/8"

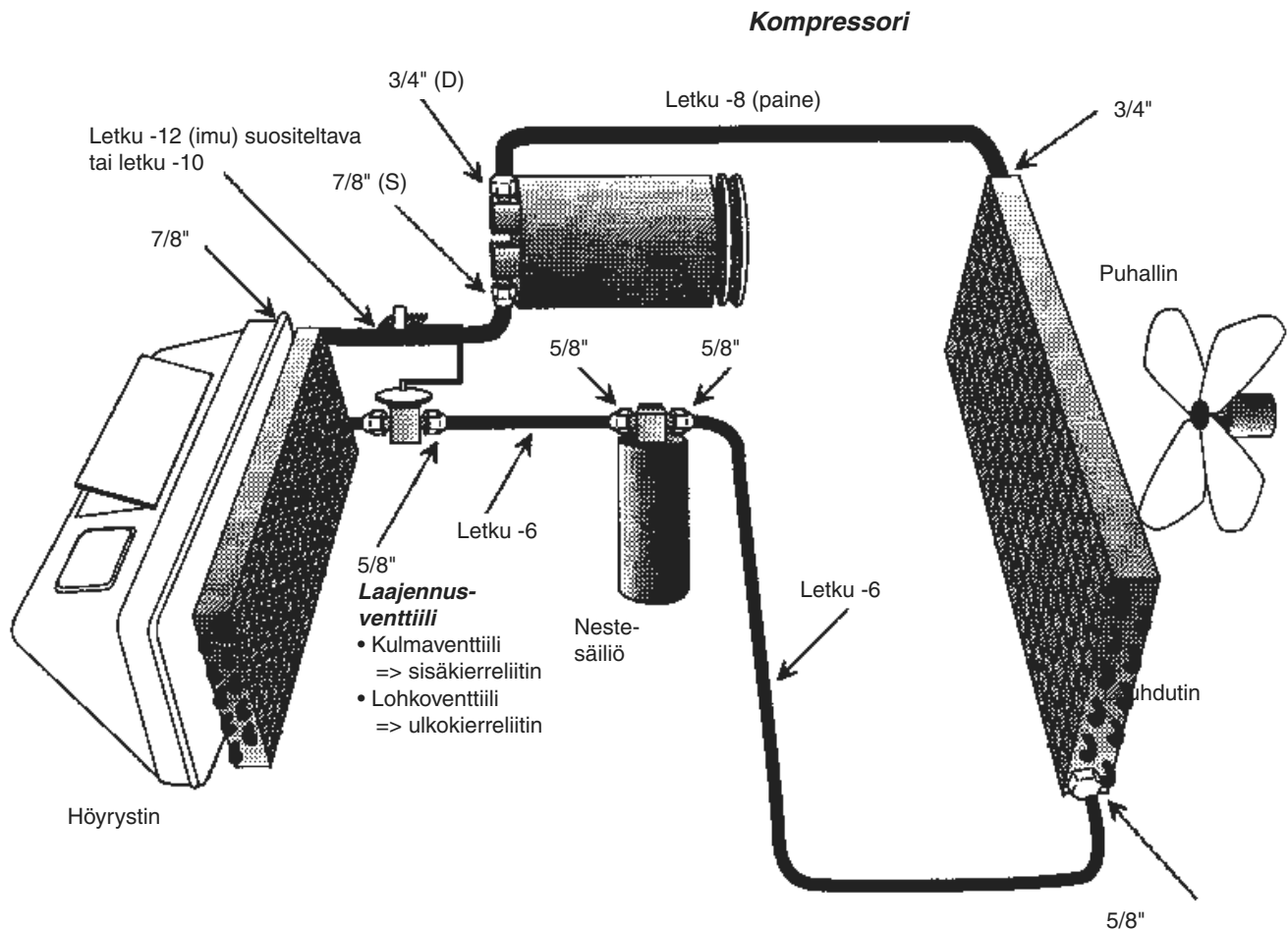



- Sisäosana nylon-putki, joka takaa parhaan tiiveyden.

1

Kylmäaineletkut

Goodyear Galaxy - 4826

- puristettaville liittimille
- sopii erityisesti työkonekäyttöön

Tilausnumero	Letkukoko	Sisä-Ø	Ulko-Ø
L 20 600 00 050	Letku -6 (5/16")	8,0 mm	19,0 mm
L 20 600 00 051	Letku -8 (13/32")	10,7	23,0
L 20 600 00 052	Letku -10 (1/2")	13,0	25,4
L 20 600 00 053	Letku -12 (5/8")	16,1	28,6



2

Parker - 7634

- ohutseinämäinen letku
- puristettaville letkuille

Tilausnumero	Letkukoko	Sisä-Ø	Ulko-Ø
L 20 600 00 060	Letku -6 (5/16")	8,0 mm	14,7 mm
L 20 600 00 061	Letku -8 (13/32")	10,0	17,1
L 20 600 00 062	Letku -10 (1/2")	12,5	19,4
L 20 600 00 063	Letku -12 (5/8")	16,0	23,6



3

ATCO 3800

- jousikiristeisille liittimille

Tilausnumero	Letkukoko	Sisä-Ø	Ulko-Ø
L 20 600 00 070	Letku -6 (5/16")	8,13 mm	14,7 mm
L 20 600 00 071	Letku -8 (13/32")	10,7	17,53
L 20 600 00 072	Letku -10 (1/2")	12,95	19,8
L 20 600 00 073	Letku -12 (5/8")	16,1	24,5

Täyttää standardin SAE J2064 type C class 1.

Eristyssuojat ilmastointiletkuille

- Jos letkut ovat alttiina lämmölle tai mekaaniselle kulumiselle, voidaan käyttää suojana eristyskuoria.

L 20 600 00 019	Eristyssuoja letkukoot 6 - 8
L 20 600 00 021	Eristyssuoja letkukoot 10 - 12



Työkalusarja puristettaville letkuliittimille

- Puristustyökalusarja puristettaville ATCO-liittimille ja Goodyear-letkuille.
- Kätevä sarja, jota on helppo käyttää.
- Sarjassa on leuat 6-, 8-, 10- ja 12-letkuko'oilte.

L 20 900 09 061	ATCO 3710 puristustyökalusarja liittimille
-----------------	--

Wigam-ajoneuvoilmastointien huoltolaitteet Kahasta

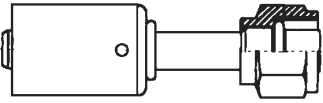
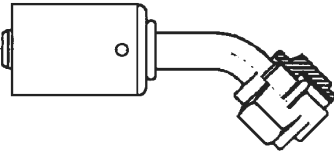
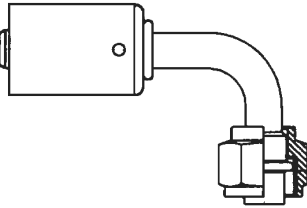
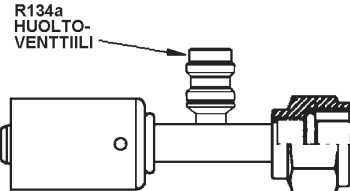
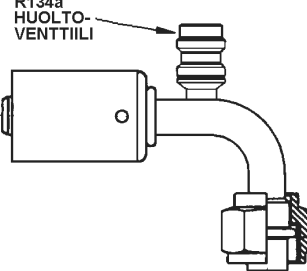
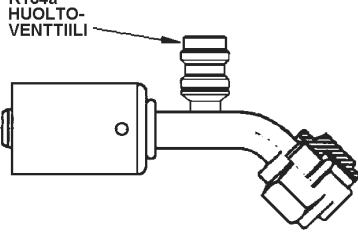
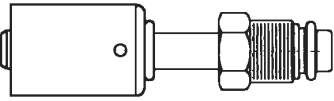
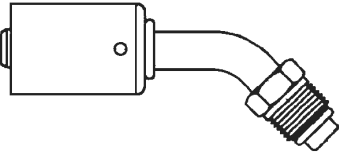

- Kahan valikoimasta löytyy huoltolaitteet ja työkalut ajoneuvoilmastointien huoltoon ja korjaamiseen.

WIGAMLU	Ajoneuvoilmastointien huoltolaiteluettelo
---------	---

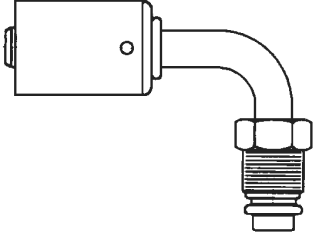
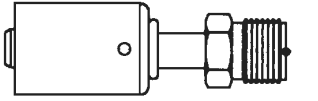
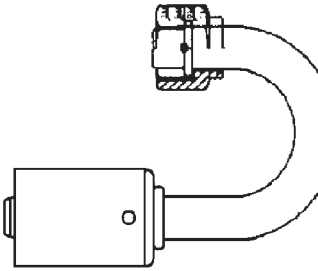
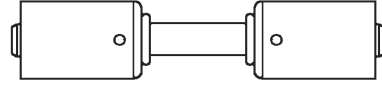
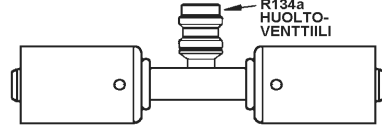
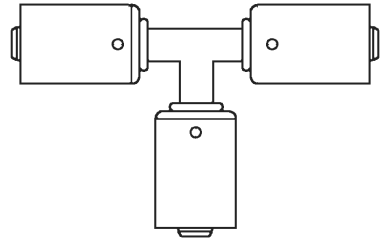
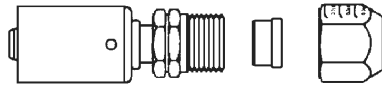
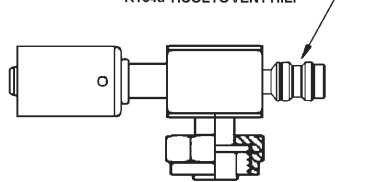
	Teräslititin	Ohutseinäinen	Kierre	Kulma	Letku	Muuta
	L 20 900 ...	L 20 900 ...				
	27 156	37 156	5/8	180	6	
	27 158	37 158	3/4	180	8	
	27 160	37 160	7/8	180	10	
	27 665	37 665	7/8	180	12	
	27 256	37 256	5/8	45	6	
	27 258	37 258	3/4	45	8	
	27 260	37 260	7/8	45	10	
	27 264	37 264	7/8	45	12	
			11/16	45	12	
	27 356	37 356	5/8	90	6	
	27 358	37 358	3/4	90	8	
	27 360	37 360	7/8	90	10	
	27 682	37 682	7/8	90	12	
	27 667	37 667	5/8	180	6	HV
	27 668	37 668	3/4	180	8	HV
	27 669	37 669	7/8	180	10	HV
	27 680	37 680	7/8	180	12	HV
	27 664	37 664	5/8	90	6	HV
	27 661	37 661	3/4	90	8	HV
	27 662	37 662	7/8	90	10	HV
	27 670	37 670	7/8	90	12	HV
	27 259	37 259	3/4	45	8	HV
	27 268	37 268	7/8	45	10	HV
	27 270	37 270	7/8	45	12	HV
	27 456	37 456	5/8	180	6	UK
	27 458	37 458	3/4	180	8	UK
	27 460	37 460	7/8	180	10	UK
	27 694		7/8	180	12	UK
	27 556	37 556	5/8	45	6	UK
	27 560	37 560	7/8	45	10	UK
	27 562	37 562	7/8	45	12	UK

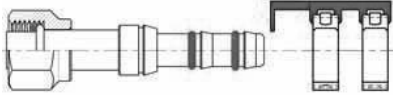
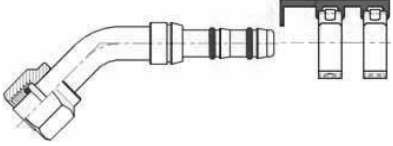
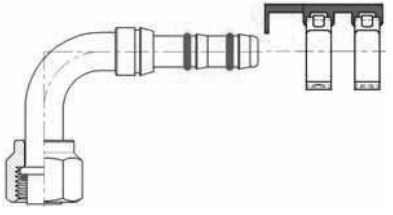
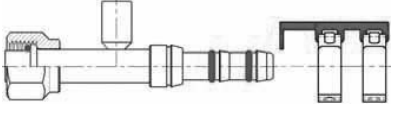
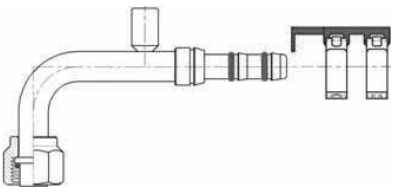
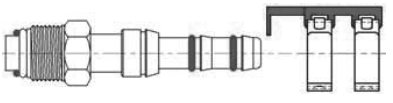
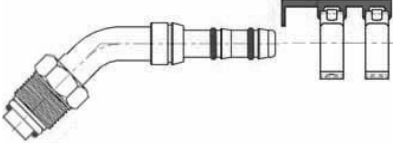
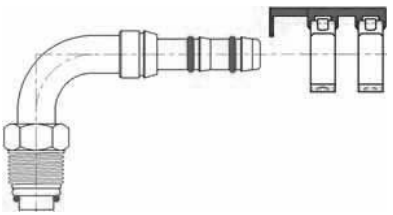
	Teräслиitin	Ohutseinäinen	Kierre	Kulma	Letku	Muuta
	L 20 900 ... 1	L 20 900 ... 2				
	27 656	37 656	5/8	90	6	UK
	27 658	37 658	3/4	90	8	UK
	27 660	37 660	7/8	90	10	K
	27 671	37 671	7/8	90	12	UK
	27 691		5/8	180	6	UK, K
	27 692		3/4	180	8	UK, K
	27 693		7/8	180	10	UK, K
	27 462	37 462	7/8	180	12	UK, K
	27 678		5/8	360	6	U-MUTKA
	27 672		3/4	90	8	UK,HV
	17 836		jatko	180	6	
	17 837		jatko	180	8	
	17 839		jatko	180	10	
	17 840		jatko	180	12	
	27 663	37 663	Jatko	180	8	HV
	27 666	37 666	Jatko	180	10	HV
	27 685	37 685	Jatko	180	12	HV
	27 683		1 1/16	90	12	
	17 830		T-liitin		6	
	17 832		T-liitin		10	
	17 833		T-liitin			
	27 701		5/8	180	3/8	
	27 702		3/4	180	1/2	
	27 703		7/8	180	5/8	
	27 710		1	90	8	
	27 711		1	90	10	
	27 712		3/4	90	8	
	27 713		7/8	90	10	
	27 714		7/8	90	12	

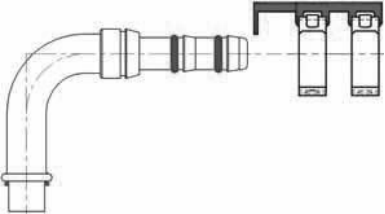
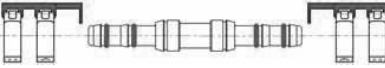
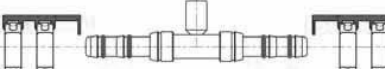
	Jousikiristeinen L 20 900 ... 3	Kierre	Kulma	Letku	Muuta
	47 156	5/8	180	6	
	47 158	3/4	180	8	
	47 160	7/8	180	10	
	47 665	7/8	180	12	
	47 256	5/8	45	6	
	47 258	3/4	45	8	
	47 260	7/8	45	10	
	47 264	7/8	45	12	
	47 701	11/16	45	12	
	47 356	5/8	90	6	
	47 358	3/4	90	8	
	47 360	7/8	90	10	
	47 682	7/8	90	12	
	47 667	5/8	180	6	HV
	47 668	3/4	180	8	HV
	47 669	7/8	180	10	HV
	47 680	7/8	180	12	HV
	47 664	5/8	90	6	HV
	47 661	3/4	90	8	HV
	47 662	7/8	90	10	HV
	47 670	7/8	90	12	HV
	47 259	3/4	45	8	HV
	47 268	7/8	45	10	HV
	47 270	7/8	45	12	HV
	47 456	5/8	180	6	UK
	47 458	3/4	180	8	UK
	47 460	7/8	180	10	UK
	47 556	5/8	45	6	UK
	47 560	7/8	45	10	UK
	47 562	7/8	45	12	UK
	47 656	5/8	90	6	UK
	47 658	3/4	90	8	UK
	47 660	7/8	90	10	K
	47 671	7/8	90	12	UK
	47 462	7/8	180	12	UK, K

		Jousikiristeinen L 20 900 ...	3	Kierre	Kulma	Letku	Muuta
	47 731			PAD	90	6	
	47 733			PAD	90	10	
	47 307			jatko	180	8	
	47 507			jatko	180	10	
	47 508			Jatko	180	10	HV
	47 707			Jatko	180	12	HV
	47 006			jousi		6	20 kpl
	47 007			jousi		6	1 kpl
	47 008			jousi		8	20 kpl
	47 009			jousi		8	1 kpl
	47 010			jousi		10	20 kpl
	47 011			jousi		10	1 kpl
	47 012			jousi		12	20 kpl
47 013			jousi		12	1 kpl	

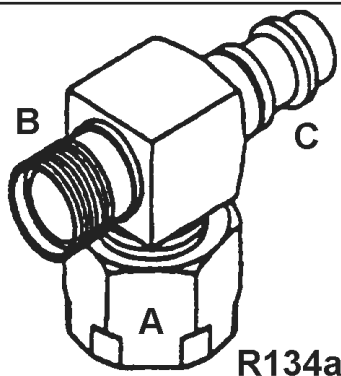

R134a

Huoltoventtiilit kompressoriin

- Sanden ja Diesel Kiki kompressoreihin.

90° (O-rengas)

Tilausnumero	C	A	B	Huolto-	Kompr.	Kierre	Letku
				venttiili	kierre		koko
L 20 900 17 805	16 mm	1" -14	3/4"-16				8
L 20 900 17 804	13 mm	1" -14	7/8"-14				10
L 20 900 17 803	16 mm	3/4"-14	3/4"-16				8
L 20 900 17 802	13 mm	7/8"-14	7/8"-14				10

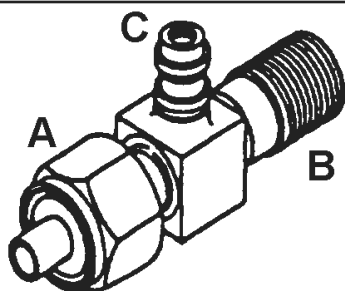

R134a

180° (O-rengas)

Tilausnumero	C	A	B	Huolto-	Kompr.	Kierre	Letku
				venttiili	kierre		koko
L 20 900 17 809	16 mm	1" -14	3/4"-16				8
L 20 900 17 808	13 mm	1" -14	7/8"-14				10
L 20 900 17 807	16 mm	3/4"-16	3/4"-16				8
L 20 900 17 806	13 mm	7/8"-14	7/8"-14				10

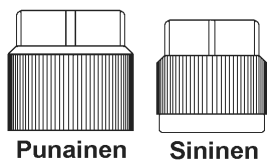

Punainen

Sininen

Venttiileiden suojahatut

L 530 1009	R134a imupuoli (sininen, 8 mm kierre)
L 530 1011	R134a painepuoli (punainen, 8 mm kierre)
L 530 4156	R134a imupuoli (sininen, 9 mm kierre)
L 530 4155	R134a painepuoli (punainen, 10 mm kierre)